

**T&T
SEEDS**



2024

***YOUR GARDEN
STARTS HERE***

ORDER EARLY AND SAVE 10%*

**ORDER BY FEBRUARY 16, 2024. MINIMUM ORDER OF \$110*



**79th
Edition**

BOX 1710 WINNIPEG
MANITOBA R3C 3P6

WWW.TTSEEDS.COM

ORDERING INFORMATION

Place your order at any time for all seed and accessories. All bulbs and perishable orders can be placed until approximately June 15, subject to availability.

ACCEPTED PAYMENT (C.O.D. not accepted):

- Cash
- Visa or Mastercard – **fully billed immediately upon receipt of order.**
- Personal Cheque made out to T&T Seeds Ltd. We do not accept post-dated cheques. A \$25.00 service charge will be issued on any cheques returned to us by the banks.
- Money Order

CHANGES, CANCELLATIONS

Any cancelled or changed orders will be subject to a \$10.95 restocking fee.

MULTIPLE ORDERS

Each order sent in will be treated as a separate order and must include the shipping and handling charges. **NO** adding to existing orders.

CATALOGUE PRICES EFFECTIVE UNTIL OCTOBER 31, 2024

Our website will reflect our current prices, which supersede those in print.

GUARANTEE

SEED GUARANTEE

All seed supplied by us meets or exceeds Canada's #1 standards. However, even with the highest quality product, success depends largely upon cultivation, soil and weather conditions. Our liability, therefore, is limited to the amount actually paid for the products purchased. We will replace the product or credit your account with the amount paid at our discretion. Deadline for reporting any seed problems is **July 15th** in the year purchased.

Shipping:

- All seed packets and gardening accessories will have a standard \$11.95 shipping fee
- All perishable items will have a standard \$13.95 shipping fee.

PERISHABLE STOCK GUARANTEE

All bare-root products are shipped in a dormant state. Often that state can cause the plant to look as if it's dead. This is completely normal. The item must be planted in the ground for at least 6 weeks to give it a chance to break dormancy.

All Warranty Claims:

- Must be made 6 weeks from the date of pick up/delivery of the item
- Plants must be fertilized, watered, and properly maintained to receive a full claim
- Warranty claims must be submitted by email or mail
- Warranty claims will not be processed without photos
- Warranty claims are not permissible on any plant that has broken dormancy.

***All claims must be submitted before October 31, 2024 and include:**

Customer # and Sales Order #

Photos of plant(s) that did not break dormancy, information about fertilizer used and date of planting

***We Do Not Cover Overwintering**

WE DO NOT REFUND SHIPPING COSTS.

CLAIMS CANNOT BE MADE ON REPLACEMENT ITEMS.

ABOUT OUR PERISHABLE STOCK

We purchase our perishable stock from all over the world. All stock is shipped into our Headingley warehouse, where it is packed and stored under temperature controlled conditions. This ensures the stock is kept dormant and fresh, right until we ship your order. We buy stock that is hardy to zones 2 and 3. If it is not, we state this in the description.

Upon arrival of your order, make sure you open and inspect it immediately to ensure everything is to your satisfaction. If not, let us know immediately so we may correct it. It is our continuous endeavour to provide our customers with healthy perishable items. Young trees, shrubs or rootstock are dormant and are not actively growing - this may give the impression of being dead, however it is in a waiting state and needs to be planted in order to grow.

SHIPPING DATES

We ship our orders across Canada by Canada Post. Most orders leave our warehouse within 48-72 hours, however there may be delays due to supply and processing times may vary due to increased demand.

PERISHABLES SHIPPING SCHEDULE

Province	Seed/Accessory	Perishables
BC	48-72 Hours	April/May
AB, SK, MB, ON, PQ	48-72 Hours	April/May
Maritimes	48-72 Hours	April/May
NWT	48-72 Hours	May/June

We watch the weather closely and will ship stock accordingly--northern areas will ship later than southern areas. This is an approximate guide. **We email shipping notification when your order is sent if an email address has been included with your order.**

NOTE: Perishable stock only ships during spring

HOW TO ORDER FROM T&T SEEDS

Please read carefully

ORDER ONLINE

You can find an order form on our website under **Catalogue/Order Form (for print)** or **Quick Order Form (complete online)**.

If it's a local order, you can request in-store pick up. A \$5.75 service fee will be applied for all pick-up orders.

PHONE US WITH YOUR ORDER

Call 1-204-895-9962 - press "2" (collect calls will not be accepted). We do not offer layaways.

Payment options: Visa or Mastercard

SEND ORDER BY MAIL OR FAX

You can find an order form on our website under **Catalogue/Order Form (for print)** or on page 3 of this catalogue.

When you fill out the order form please confirm if you intend to pick up your order. Provide the following information for each item you wish to order:

1. Name of Item | Catalogue Item Number | Packet Size | Quantity | Price
2. If ordered by Feb. 16, 2024, and your order is over \$110 (before taxes and shipping) deduct 10%.
3. Add the shipping charges:
\$11.95 for seeds and accessory orders. Check out our Special \$5.75 shipping fee on page 5!
\$13.95 for perishable stock.

NOTE: Seeds and perishable items are stored and shipped separately. If your order includes both, then you will need to add both shipping charges.

Large orders and/or remote locations will incur extra shipping charges. We retain the right to adjust shipping prices accordingly and will notify you.

4. Add the taxes:

BC	AB	SK	MB	ON	PQ	NB	NS	PE	NL	NT	YT	NU
5% GST	5% GST	5% GST	5%GST 7%PST	13% HST	5% GST	15% HST	15% HST	15% HST	15% HST	5% GST	5% GST	5% GST

5. Include your full mailing address, email and phone number. Shipping information will be emailed to you once the order has been shipped.
6. Mail to: T&T Seeds, Box 1710, Winnipeg, MB R3C 3P6

All orders shipped via Canada Post

FAX ORDER TO:

1-204-895-9967

Payment options: Visa or Mastercard only

SHOP AT THE STORE

Our retail store is located in Headingley - 7724 Roblin Blvd. just west of Winnipeg. We carry all seed and accessories found in our catalogue. We only carry perishable items from the catalogue during spring season. We have a huge selection of bedding plants and potted nursery stock from spring to fall and our store is open year-round! Stop by, we'd love to see you!



Let's Connect!
Find us on Instagram and Facebook



2024 ORDER FORM

Mail to: T&T Seeds Ltd. Box 1710 Winnipeg, Manitoba R3C 3P6

PLEASE DO NOT USE TAPE OR STAPLES

For Office Use Only

Name (First, Last) Customer Number (6 digits)

Box # or Street Address

Town/City Province Phone

Postal Code Email (for notification of shipping)

**Payment must be by cheque, money order or credit card.
We do not accept C.O.D. or post-dated cheques.**

Card Number

--	--	--	--	--	--	--	--	--	--	--	--	--	--	--	--	--	--	--	--

Credit Card orders are fully billed when we receive them.

<input style="width: 100%; height: 20px;" type="text"/> Signature	Expiry Date <table border="1" style="width: 100%; border-collapse: collapse;"> <tr> <td style="width: 20px; height: 20px;"> </td> <td style="width: 20px; height: 20px;"> </td> <td style="width: 20px; height: 20px;"> </td> <td style="width: 20px; height: 20px;"> </td> </tr> </table>					CVV <table border="1" style="width: 100%; border-collapse: collapse;"> <tr> <td style="width: 20px; height: 20px;"> </td> <td style="width: 20px; height: 20px;"> </td> <td style="width: 20px; height: 20px;"> </td> </tr> </table>				Month Year 3 digits back of card

paid:

credit:

EARLY ORDER BONUS

Receive a 10% discount if your order is over \$110 (before taxes and shipping) and is postmarked/submitted by **Feb 16, 2024**

GIVE US A CALL

Phone your order direct to the T&T sales team by calling 204-895-9962
Payment by credit card only.

Name of Item	Catalogue Item Number	Pkt Size Code	Quantity	Price	Total Price
Cool Breeze Cucumbers	720	A	2	5.45	10.90

YES, please substitute with a similar item(s) if necessary.

PAYMENT MUST BE SUBMITTED WITH EACH ORDER

EXTRA SHIPPING CHARGES

Due to increased rates and weight restrictions on postal services, large orders will be subject to an **ADDITIONAL SHIPPING FEE**. This is dependant on postal code and weight of items ordered. These charges **will be added on** at time of processing and you will be notified.

SMALL ORDERS = LOWER SHIPPING CHARGES

Choose up to ten "A" size packets of vegetable or flower seed (collections not included) and your shipping charges are only \$5.75. Regular shipping will be applied if items are outside package limits as described above.

Subtotal		
10% Discount	If order is over \$110* and postmarked by Feb. 16, 2024	
Basic Subtotal		
ADD Shipping for Seed and Accessories		\$11.95
ADD Shipping for Perishables		\$13.95
PICK-UP SERVICE FEE	SMALL ORDER	\$5.75
GST or HST (MB residents add 7% PST)		
Total Amount of Order		
Add/Subtract any shorts (+) or credits (-)		
Amount Remitted		

*\$110 order before taxes and shipping

DORMANT STOCK 101

A rootstock is part of a plant, often an underground part, from which new above-ground growth can be produced. All bare-root stock is in a dormant state and will produce new growth after being planted. These items are not full-size, they mostly consist of just the root system. A plant that is in dormancy is not actively growing, it will only break dormancy when the conditions are suitable for active growth.

Often when a plant is in a dormant state it will appear dead. We assure you that it is still alive. If you were to cut into it, you would find at least a small amount of living green tissue, this is called the cambium.

Dormant stock comes in a wide range of shapes and sizes. You may receive products ranging in size from a few inches to as large as four feet.

Due to dormant stock being in a dark box during shipping, leaves may lose their color due to being unable to photosynthesize during transport, but after they are planted they will produce fresh leaves once rooted into the soil.



Bare Root



Bulb



Corm

PERISHABLE STOCK CARE

Plant energy flows bi-directionally, much like blood in the human body. Upon receipt of your bare root, prune the product back by 2-3 inches. The amount will depend on the size of the plant. This will help to push energy back down into the roots. Make sure that you are cutting down far enough that you can see the cambium. The roots are small compared to the area they are being planted in, so a smaller tree puts the roots and plant in balance to use energy for new growth.

Rootstock must be fertilized once every two weeks from planting until mid to late August. This is a crucial step in ensuring the plant will break dormancy. We recommend using a well-balanced fertilizer (ex. 14-14-14) to help encourage root and bud development. It is important to stop fertilizing towards the end of the summer to encourage the plant to enter back into dormancy to survive the winter.

If the plants come in soil, they are ready to be planted after pruning. If the plants come in mulch/shavings, they need to be rehydrated. Rehydrate the roots by soaking them in a pail of water for several hours or overnight (we recommend 24 hours). During the soaking process, most dormant stock starts to bud out. Sometimes they don't bud until planted. Every plant is different!

To plant, dig a hole that is deep enough to accommodate the height and width of the root system. This gives the roots plenty of room to grow outwards. Use a spade to break up any compacted soil around the sides and bottom of the hole. Throw in a few shovelfuls of compost, then fill the hole with water and let it drain.

Position the plant upright, it is okay for the rootball to be sideways in the hole. Gently backfill the hole with loose soil. Steady the plant with one hand, then use your hands or feet to gently firm in the soil and stabilize the plant. Water thoroughly to remove any air pockets and settle the soil around the roots.

MUST HAVE COLLECTIONS



695 T&T's Great Pickles Seed Kit (with recipe)

- 50 gram package of Tendergreen beans
- 25 seeds of King of the Castle cucumbers
- 250 seeds of Fernleaf Dill
- 15 seeds of Noche Zucchini
- 7 gram package of Nantes Carrots

Our popular brine recipe

20% Savings compared to individual purchases!

Each package **A** \$19.50



3030 Biggest Tomatoes Kit*

Four products designed to help grow BIG, healthy tomatoes.

- Talk of Tomatoes Calcium
- Tomato Ripener
- Wormgold
- Fusion Natural Fertilizer

Each kit **A** \$59.95



3031 The Essential Fertilizer Kit*

Can be used on everything you grow, as an all-around, catch-all fertilizer, both on veggies and flowers.

- Hose end sprayer
- Rose & Strawberry Fertilizer
- Liquid Seaweed
- Wetting Agent

Each kit **A** \$58.95



3025 Seed Starting Kit*

Everything a new seed gardener needs to get going!

- Heat mat
- T&T Starter Kit
- Labels & Marking Pen

Each kit **A** \$45.95

STORING SEEDS

Now you have your seeds. How do you store them safely? The secret is in two words: cool and dry.

Storing seeds properly will allow you to keep them viable for as long as possible. Here are a few tips for successfully storing your seeds:

- Humidity and warmth will shorten a seed's shelf life
- Store seeds in envelopes and put in an airtight container
- Containers can be glass, metal, or plastic
- For long-term storage, if you don't have an area with consistent temperatures, consider freezing seeds in a glass jar. The refrigerator rates second-best as temperatures are not as consistent

Remember...

Taking your seeds out of the freezer or refrigerator

This part is very important for ensuring the quality of the seeds.

- Set the jar out on a kitchen table or shelf for 12 hours so it can reach room temperature. This will prevent moisture from condensing on the seeds
- Expose the seeds to air by opening the lid for a few days before planting
- Refrain from moving seeds from the freezer to room temperature more than once, as each transfer will reduce the viability of the seeds

5 EASY WAYS TO ORDER!

ONLINE | WWW.TTSEEDS.COM

BY PHONE | 1-204-895-9962 – PRESS "2"

BY MAIL | BOX 1710 WINNIPEG, MB R3C 3P6

BY FAX | 1-204-895-9967

IN PERSON | 7724 ROBLIN BLVD. HEADINGLEY, MB

EXTRA SHIPPING CHARGES

Due to the increased rates and weight restrictions on postal service, large orders will be subject to an additional shipping fee. This is dependant on postal code and weight of items ordered. These charges will be added at time of processing and you will be notified.



= Heirloom Seed

Look for this symbol on seed. These varieties are proven old time favourites and are open-pollinated.

NOTIFICATIONS

Make sure you include your **email** on your order form so we can send you shipping notifications.



HAVE A QUESTION? We Can Help!
garden@ttseeds.com



GIFT CERTIFICATES

Give the gift that keeps growing! Gift certificates never expire and can be used in-store or online. Purchase online or through your mail order.

Check out **Page 2** of this Catalogue for:

Instructions on How To Order from T&T Seeds

Ordering Information

Our Seed and Perishables Guarantee



When you succeed, we succeed!
We always welcome feedback!

WHAT'S INSIDE

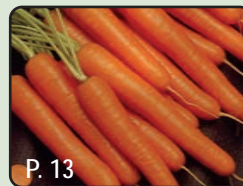

P. 13

VEGETABLE SEEDS

p. 6-37

- Herbs 18, 19, 23
- Peppers 24-25
- Seed Tapes 33
- Ethnic Vegetables 34
- Sprouting Seeds 35

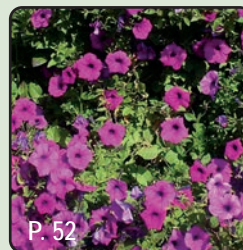

P. 52

FLOWER SEEDS

p. 41-60

- Perennials 41, 42
- Flower Blends 42
- Geraniums 46
- Climbers 60
- Petunias 52-55
- Foliage types 59
- Zinnias 57-58

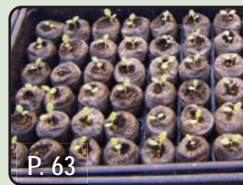

P. 63

SUPPLIES

p. 62-71

- Starting seed 62-63
- Fertilizers 64-66

- PERISHABLE STOCK -



P. 77

BULBS & TUBERS

- Callas 73
- Acidantra 73
- Gladiolus 74
- Dahlias 75
- Lilies 78-79

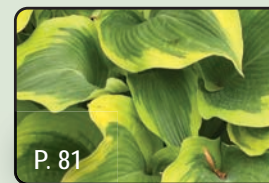

P. 81

PERENNIAL PLANTS

p. 76-81

- Hostas 81
- Grasses 82

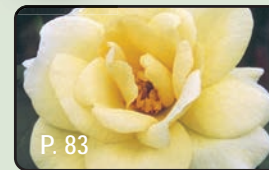

P. 83

ROSES

p. 82, 83

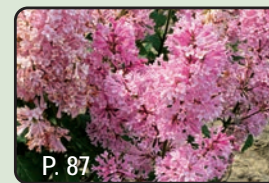

P. 87

SHRUBS, VINES, HEDGING AND TREES

- Flowering Shrubs 87
- Hedging, Trees 85-89
- Vines 84



P. 90

FRUIT, BERRIES, POTATOES, ONIONS

P. 90 - 99, 104

- Asparagus 100
- Onion Sets, Garlic, Seed Potatoes... 102-103

- New & Notable Items 40
- Policy & Guarantee 2
- Health Products 61

BEANS

PICKLING BEAN



55 Dandy Gold (54 days)
Medium 10 cm (4 in), smooth, round-podded beans. They are very early and hold the pods high off the ground on an erect compact bush. This bean is an ideal shape for french cut, canning, freezing or ideal for making dill beans.



85 Tendergreen (52 Days)
This early and heavy yielding bean has been a reliable producer for years! Smooth dark green skin, pods are 15 cm (6 in) long. Excellent freezing variety. Bush.



40 Gold Rush (53 Days)
An improved Majestic type bean, with beautiful, round, 15 cm (6 in) long, straight pods. Beans are held off the ground for easy picking. Bush.



125 Oakley (55 Days)
A true gourmet bean that will be a big hit if you are looking for a specialty gourmet bean. High quality, uniformly sized pods that have a dark green colour, outstanding flavour and texture, and also great for canning. Please note Pkt. A is 25 grams.

BEAN PRICES (For page 6 and Pole Beans page 7)

50 grams	A	\$4.25	500 grams	H	\$14.95
125 grams	F	\$6.15	2 Kilos	J	\$39.95
250 grams	G	\$8.30			

Save! Buy any three (or more) A size \$3.90 each

50 grams of bean seed sows about 6 m (20 ft) row.
**** Estimated 900 seeds per 250 grams ****



35 Sassy Hybrid (57 days)
Tender, dark green beans are delicious, crunchy and have a great delicate flavour! The 10-13 cm (4-5 in) long pods are the perfect size to use whole for fresh eating, canning and freezing. Vigorous plants produce outstanding yields of top-quality beans and are quick to set another crop after picking. Height: 18-24 in bush.



65 Green Roma II (55 Days)
The most delicious beans you will grow this season! Roma has long, fleshy, tender pods; excellent even when the pods are quite large and plump. The Roma types are very productive over a long season. Bush.



20 Purple Royalty (53 Days)
When cooked, purple pods turn deep green. It has a very rich flavour. A superior quality which germinates better in colder soils than other beans. Bush.



75 Provider (52 Days)
Not only does this bean germinate in cold wet soil, giving you earlier crops, but it's so melt-in-your-mouth tender. Excellent yields over a longer period. Thick pods are 14 cm (6 in) long. Use fresh in salads or for pickles. Bush.

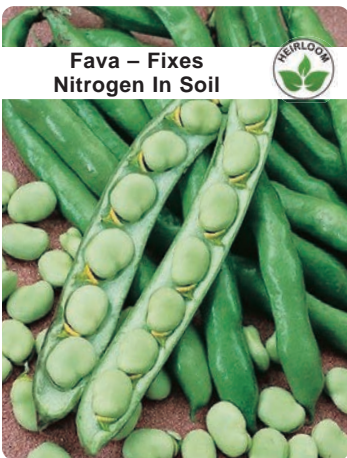

140 Broad Windsor (65 Days)
The green seeds are shelled and cooked when the pods are filled. Delicious with butter and fresh ground pepper. Bush.



105 Flambo (75 to 95 Days)
Pods average 14 cm (5 1/2 in) and contain attractive, speckled beans. For shell beans, harvest when pods turn dark red with a yellow background. Flambo is excellent fresh, frozen, or canned. Also makes a fine dry bean. Bush.



100 Strike (50 Days)
Extremely early yet very high yielding. Exceptionally tender and extra smooth when picked young. Straight 12 cm (5 in) pods. The earliest bean in our trials. Bush.

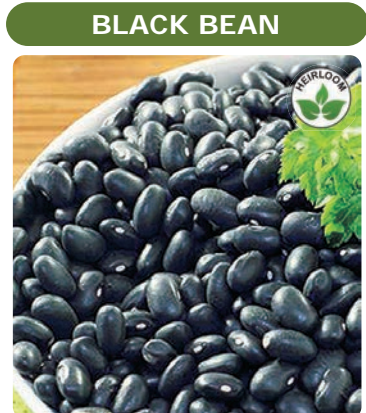

150 Black Turtle Bean (85 Days)
High yielding bushes benefit from some support. Black beans are loaded with protein, fibre, molybdenum, zinc, and copper. This black bean has a dense, meaty texture, which makes it popular in vegetarian dishes.

"All our beans are stringless"

*Manitoba residents: these items are taxable

POLE BEANS

Easier to pick than bush beans and no succession planting is needed. It's true that pole beans may take a little longer to start producing, but there's no comparison to their longevity!



Attracts Hummingbirds

155 Scarlet Runner (65 Days)
A quick-growing, climbing bean with very attractive bright scarlet-red flowers. Vines are 3 m (9 ft) high. Pods are 20 cm (8 in) long and tender when young. **Prices and package sizes on page 6.**



French filet style

110 Emerite (53 Days)
A French filetstyle bean. Vines can grow up to 2.4 m (8 ft), and produce a bounty of attractive, slim, 18-22 cm (7-9 in) beans that have a sweet, delicate flavour! **Prices and package sizes on page 6.**



107 Kentucky Blue (60 Days)
All-America selection winner combines the qualities of Kentucky Wonder and Blue Lake. Healthy, vigorous vines produce round, straight pods of excellent quality. 18 cm (7 in) beans. A great climber! **Prices and package sizes on page 6.**



112 Carminat (62 Days)
Beautiful, slender, purple pods. Much nicer than older purple pole bean varieties. Harvest pods at 8-9". Excellent, rich, and slightly sweet flavour. Suitable for fresh use in salads or cooked. Beans turn green when cooked.

Pkt. 25 seeds **A** \$5.25; 100 seeds **B** \$9.95; 200 seeds **C** \$17.90



1310 Orient Wonder Pole Beans (70 Days)
Also called asparagus beans or Chinese long beans. This variety produces rich green, long, slender, round, stringless pods. These beans are very crisp, tender and delicious. Far superior to standard varieties for its flavour and ability to grow in a wide range of conditions. **Package sizes limited on this variety, only available as below.**

25 seeds **A** \$4.70; 100 seeds **B** \$8.80; 500 seeds **C** \$23.40



168 Red Noodle (80 Days)

This impressive pole bean produces masses of two foot long, deep red beans! These beans stay red even after cooking. Although they can grow to two feet, beans are at their best at around one foot. Long vines produce all summer and do well under many conditions. Open pollinated.

Pkt. 25 seeds **A** \$5.80; 250 seeds **B** \$9.95; 500 seeds **C** \$17.90

TEPARY



160 Tepary Brown (80 Days)
Indigenous to North America and developed thousands of years ago to be drought-tolerant. Higher in protein and fibre than other beans. An appealing nutty, sweet flavour completely different from other beans. The small beans plump up a bit but keep a meaty, dense texture.

Pkt. 100 seeds **A** \$3.85; 500 seeds **B** \$9.95; 2,000 seeds **C** \$23.40

FOR BEST CROPS



Not just for peas or beans, but all seeds you grow! Dusk inoculant (rhizobial bacteria) onto beans or peas before planting to draw more nitrogen for plants.

Replacement for Nature's Aid

3276 Seed Dressing Inoculant*

Sufficient material to pre-inoculate up to 3.6 kilos (8 lb) of seed prior to planting.

42 grams (1.5 oz.)

A \$11.95; 2 or more \$10.95

DID YOU KNOW?

Plant Beans In Warm Soil!

Beans need a temperature of at least 16C or higher to properly germinate. Any soil temperature lower than that and you could risk causing permanent shock to the plants. Test your soil temperature with our digital soil thermometer p.71) to ensure your soil is warm enough before planting.

EDAMAME BEANS (SOY BEANS)



95 Midori Giant (80 Days)
The best for delicious, fresh-from-the-garden edamame. Pods are filled with 2 or 3 extra-large, round, buttery beans with a sweet flavour and fresh bite. Large, vigorous, 2-3 ft plants are heavy producers. Very high in protein, iron and fibre. Healthy snack food!

Pkt. 25 seeds **A** \$5.65; 250 seeds **B** \$17.50; 500 seeds **C** \$31.50

Soy Beans are very quick growers, which means that getting an early start can give you a couple of weeks growth early in the season. Imagine being able to harvest two or three weeks earlier! Root shock can be avoided when starting beans indoors by starting them in peat pots.

CHICKPEAS



1315 Orion Chickpeas (75 Days)
Orion is a large-seeded kabuli chickpea developed by University of Saskatchewan, especially for a shorter growing season. Chickpeas, also called garbanzo beans, are beige-coloured, pea-shaped legumes. Popular in the Mediterranean, Middle East and South Asia, they have a mild nutty taste and are a tasty alternative protein. Very, very nutritious!

Pkt. 50 seeds **A** \$5.65; 250 seeds **B** \$17.50; 500 seeds **C** \$31.50

CUCUMBERS



Heavy Producer

714 Green Light Hybrid (42 Days)

Grow on stakes or poles, for an easy-to-harvest vertical garden that will yield 40 or more spineless fruits per plant. Pick the fruits when they're small, between 7 to 10 cm (3 to 4 in) long, and you'll be rewarded with great tasting cucumbers, even without peeling. Succession plantings will ensure a summer-long harvest.

Pkt. 25 seeds **A** \$6.00; 250 seeds **B** \$26.40; 500 seeds **C** \$47.50; 1,000 seeds **D** \$71.25



780 Cucamelon (67 Days)

These tiny watermelon look-a-likes (on the outside) have a refreshing flavour. Their lush vines will produce masses of fruit throughout the summer with a cucumber-lime taste. Perfect for snacking, pickling or adding to salads.

Pkt. 25 seeds **A** \$4.80; 100 seeds **B** \$9.95; 200 seeds **C** \$17.90



730 Lemon Apple Cucumber (60 Days)

Vigorous and productive variety that produces fruits about the size and colour of a lemon. Flesh is crispy white, sweet, and burpless. The fruit is ripe when it first starts to turn yellow, but can be used green or ripe.

Pkt. 25 seeds **A** \$4.80; 5 grams **B** \$6.25; 10 grams **C** \$11.25; 25 grams **E** \$21.95



706 Parisian Gherkin Hybrid (60 Days)

An excellent mini or Gherkin pickling cucumber which can be picked either at the mini size or small pickle stage. The numerous black spined cucumbers can also be enjoyed fresh in salads and slaws. They have a sweet flavour and process into pickles well. The semi-vine plants can be planted in the garden or staked patio containers. A very easy-to-grow disease resistant variety!

Pkt. 25 seeds **A** \$5.45; 100 seeds **B** \$17.50; 200 seeds **C** \$31.50; **E** \$55.95

Feature **Greenhouse Cucumber**



790 Holland Hybrid (64 Days)

This greenhouse cuke will set high numbers of long, straight hot-house type fruit without the aid of cross-pollination. Fruit is 37 cm (15 in) long and very sweet.

Pkt. 5 seeds **A** \$15.75; 25 seeds **B** \$48.00; 50 seeds **C** \$86.40



698 Straight 8 (60 Days)

One of the top slicers produced. The dark green skin covers crisp, juicy white flesh. The seed mass is small and solid.

Pkt. 3 grams **A** \$4.80; 12.5 grams **D** \$6.50; 25 grams **E** \$11.70; 125 grams **F** \$18.50; 500 grams **H** \$34.00

Feature **English-Type**

Grow On A Trellis



715 Sweeter Yet Hybrid (48 Days)

Sweeter tasting burpless type! Fruit is dark green with a thin non-bitter skin, no need to peel. Harvest fruit when they reach 30 cm (12 in) long and 5 cm (2 in) in diameter. Semi-determinate vines can be grown on a trellis or along the ground.

Pkt. 25 seeds **A** \$6.00; 250 seeds **B** \$39.10; 500 seeds **C** \$70.40; 1,000 seeds **E** \$109.00

No Peeling



710 English Burpless Hybrid (60 Days)

Has the finest, mildest eating quality of any cucumber on the market. Ideal for growing on stake or trellis. Crisp, tasty, not bitter and truly burpless. 25 cm (10 in) by 4 cm (2 in) in size.

Pkt. 25 seeds **A** \$6.00; 250 seeds **B** \$24.60; 500 seeds **C** \$44.30; 1,000 seeds **E** \$68.75

Boost Cukes!

3258 Corn & Cucumber Fertilizer (25-0-0 + Sulphur)*

When cukes start forming – feed with this every two weeks for the plumpest, best-tasting cucumbers!

227 gram **A** \$12.95; 2 kilos **B** \$45.50

Slicing

Japanese Cucumber



707 Summer Dance Hybrid (58 Days)

The most uniform cucumbers ever! This high yielding Japanese cucumber has a sweet crisp flavour and is burpless. Plant on a trellis for ideal production. Glossy deep green colour on 22 cm (10 in) long cukes with a diameter of 3 cm (1.5 in). Average weight is 100 grams (4 ozs).

Pkt. 15 seeds **A** \$6.00; 100 seeds **B** \$20.15; 200 seeds **C** \$36.25

740 Diva Hybrid (56 Days)

Award-winning easy-to-grow slicing Cuke! Especially flavourful when harvested small! Produces distinctly tender, crisp, sweet, bitter-free, and seedless fruit. Foliage is non-bitter, hence not as attractive to cucumber beetles as some varieties. Very disease resistant. Harvest at 10 cm (4 in) and keep on picking.

Pkt. 25 seeds **A** \$4.80; 250 seeds **B** \$16.75; 500 seeds **C** \$29.00; 1,000 seeds **E** \$46.25

Packaged by weight – Approximately 35 Cucumber seeds per gram



Seedless



740 Diva

CUCUMBERS (CONTINUED)

PICKLING (SEE DILL SEED PAGE 23)

Feature Cucumber

Uniform & Abundant!



717 Aladdin Hybrid (65 Days)
An improved salad type cucumber!
 Produces high quality 15 cm (6 in.) mini-cucumbers on a strong vine. Aladdin will set fruit consistently throughout the season resulting in a high total yield. Highly uniform fruit with a slender shape and good colour.

Pkt. 25 seeds	A	\$5.45
250 seeds	B	\$20.15
500 seeds	C	\$36.25
1,000 seeds	E	\$49.25

Customer Favourite!



720 Cool Breeze Hybrid (45 Days)
 This should be your earliest ever cucumber. All-female flowers means you don't need bees early in the season to cross-pollinate. And you get a huge crop for early pickling or salads. Harvest when 10 to 15 cm (4 to 6 in.).

Pkt. 25 seeds	A	\$6.00
250 seeds	B	28.55
500 seeds	C	\$51.40
1,000 seeds	E	\$78.95
5,000 seeds	F	\$285.00

Ideal In Containers



702 Best Slice Hybrid (57 Days)
 These delicious burpless cukes will bear continuously on early, dwarf plants. The fruit is straight, easy to slice, and good for fresh use. Large sweet bitter free fruit, 25 cm (10 in). Extremely heavy yielding when harvested regularly! The compact habit makes it ideal for the container gardener too.

Pkt. 25 seeds **A** \$4.80; 250 seeds **B** \$17.50; 500 seeds **C** \$31.50



760 King Of The Castle Hybrid (50 Days)
 The earliest and most productive! Loads of medium dark green fruit on short 1 m (3 ft) vines. The white spined fruit has a unique sweet flavour ideal for eating fresh in salads, sandwiches, perfect for any pickle recipe.

Pkt. 25 seeds **A** \$4.80; 250 seeds **B** \$16.75; 500 seeds **D** \$30.15; 1,000 seeds **E** \$36.95; 5,000 seeds **F** \$118.95; 20,000 seeds **H** \$396.25

Packaged by weight - Approximately 35 Cucumber seeds per gram



700 Eureka Hybrid (57 Days)
 This may be the only cucumber you need to plant! Impossible to define as a 'pickler' or 'slicer'—because it is both! A great dark green salad cucumber from small sizes on up, and it's a marvelous pickling cuke from 5 cm – 12 cm (1 1/2 – 5 in) long. Also very disease resistant.

Pkt. 25 seeds **A** \$4.80; 250 seeds **B** \$16.95; 500 seeds **C** \$30.50; 1,000 seeds **E** \$61.00

Old Time Favourite!



770 National Pickling (55 Days)
 A very popular older variety that has been a staple for gardeners since 1924! Vigorous dark green vines will produce perfect 15 cm (6 in) blunt ended pickling cukes. Excellent flavour!

Pkt. 3 grams **A** \$4.80; 12.5 grams **D** \$8.95; 25 grams **E** \$14.50; 125 grams **F** \$24.60; 500 grams **H** \$47.95

Container Cucumber



704 Patio Snacker Hybrid 60 Days)
 Patio Snacker is the perfect cucumber for containers, trellis or smaller gardens. Short branching vines produce dark green 20 cm (8 in) fruit with a nice flavour, crunchy texture and non-bitter peel. High yielding, once production starts it continues all summer long!

Pkt. 10 seeds **A** \$4.80; 50 seeds **B** \$17.50; 100 seeds **C** \$31.50



703 Bush Pickle Hybrid (48 Days)
 These have a short growing season and the plants only grow 60-90 cm (24-36 in), making them ideal for small gardens. They are also excellent for container gardening. Fruits grow up to 12 cm (5 in) long and taste mild and crispy.

Pkt. 25 seeds **A** \$4.80; 250 seeds **B** \$15.80; 500 seeds **C** \$28.45

Great For Gherkins

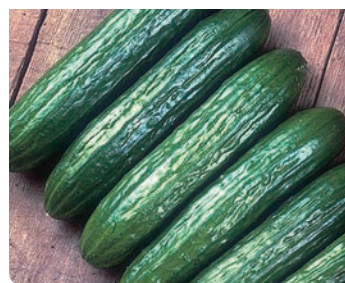

1072 Babylon Hybrid (56 Days)
 New and improved "Amira"! This smooth-skinned cucumber (spineless) needs to be picked at about a 15 cm (6 in) size. Eat like an apple! Flavour is sweet, crunchy, burpless and very prolific.

Pkt. 25 seeds **A** \$5.45; 250 seeds **B** \$25.75; 500 seeds **D** \$46.35; 1,000 seeds **E** \$92.70



755 Homemade Pickles (55 Days)
 Developed for home pickling! Fruit are medium green with small white spines and can be harvested from 4 cm (1.5 in) - 15 cm (6 in) long. Heavy producer!

Pkt. 50 seeds **A** \$4.80; 12.5 grams **D** \$8.75; 25 grams **E** \$15.75; 125 grams **F** \$24.70; 500 grams **H** \$49.00

CABBAGE

SUPERSWEET CORN TYPES (SH2)

FEATURE CABBAGE



360 Storage #4 Cabbage Hybrid (90 Days)
 Very early variety produces very flavourful 4 kg (8 lb) blue-green cabbage. An excellent yielding and long-term storage variety. Holds well in field during weather stress. Suitable for home gardens as well as farmer market producers.
 Pkt. 50 seeds **A** \$4.80; 500 seeds **B** \$19.00; 1,000 seeds **C** \$34.20



303 Golden Cross Hybrid (40 Days)
 Very compact growth allows close spacing. Plant produces very flavourful heads of cabbage. One of the earliest maturing around. Can be grown from spring to fall.
 Pkt. 50 seeds **A** \$4.80; 500 seeds **B** \$19.00; 1,000 seeds **C** \$34.20



1330 Taiwan Cabbage Winner (73 Days)
 Forms solid yellow-white oval heads which collapse at maturity enabling easy separation of leaves. Average 2 kg (4 lb) at maturity. A mild flavour is great for cabbage rolls, boiled, steamed, pan or stir-fried, stuffed and pickled. A customer favourite!
 Pkt. 50 seeds **A** \$4.80; 250 seeds **B** \$13.95; 500 seeds **C** \$25.10

Feature Monster Cabbage



355 O.S. Cross Hybrid (100 Days)
 The largest we have ever seen grown. Exceptionally uniform, enormous, flat, heads. Great for exhibition and good eating. Ideal for making sauerkraut. A customer favourite for years!
 Pkt. 50 seeds **A** \$4.80; 500 seeds **B** \$17.00; 1,000 seeds **C** \$30.60; 5,000 seeds **E** \$82.75



357 Red Jewel (75 Days)
 Beautiful garnet colour makes this early, delicious cabbage a standout at the table! Produces large, tightly packed hearts with crisp leaves. Size is 1.5 kilo (3 lb).
 Pkt. 50 seeds **A** \$4.80; 500 seeds **B** \$18.95; 1,000 seeds **C** \$34.10

3372 Safer's BTK Biological Insecticide*
 Contains bacillus thuringiensis, a bacterium that kills all types of caterpillars including spruce budworm, cutworms, canker worms, forest tent caterpillars, **cabbage worm** (also the larvae of potato bugs & **lily beetles**) by infecting their digestive systems. Just spray on leaves. As soon as they ingest it they stop feeding and die. Concentrated: makes 30



litres (7 gal) of spray.
Safe for animals and people!
 100 ml bottle **A** \$16.95; 2 or more \$15.95 each



Tronchuda Type- Sweet & Mild



305 Sweet Thang Hybrid (65 Days)
 This excellent non-heading cabbage offers thick, sweet-tasting white veins with vibrant attractive dark green leaves. Features a very uniform habit and short core.
 Pkt. 50 seeds **A** \$4.35; 250 seeds **B** \$16.95; 500 seeds **C** \$35.70

Hybrid Sweet Corn

Very sweet. "Crunchier" and longer shelf life than other types. Must be isolated at least 100 feet or more from other corn of similar maturity days to avoid cross-pollination, at least 10 days difference!



514 Northern Extra Sweet

Our Best Selling Corn

FEATURE CORN

514 Northern Extra Sweet Hybrid (SH2) (62 Days)
 The earliest supersweet available! The large cobs 20 cm (8 in) have excellent tip fill. This hybrid shows improved emergence and vigor under cool, wet soil conditions.
Prices below



516 Early Extra Sweet

516 Early Xtra Sweet Hybrid (70 Days)
 Actually gets sweeter after you pick it! Slow to convert its sugar to starch, great for freezing or market sale. 25 cm (10 in) cobs have 14-16 well-filled rows.
Prices below



526 Sweetness Bi-colour

526 Sweetness Bi-Colour Hybrid (68 Days)
 Sweet to the last kernel, this corn raises the bar for sweetness. Delectable, picture-perfect bi-colour kernels on 20 cm (8 in) cobs. Extra early with good cold soil vigor.
Prices below

Prices for 514, 516, & 526

Pkt. 150 seeds **A** \$7.15; 500 seeds **F** \$17.80; 1,000 seeds **G** \$32.05; 2,500 seeds **H** \$60.95; 10,000 seeds **J** \$185.00; 20,000 seeds **K** \$333.00



Exceptional Sweetness & Flavour

548 Vision Hybrid (75 Days)
 Tender, bright yellow kernels in 16-18 rows on ears that are 20 cm (8 in) long. Excellent husk protection and good cool-soil vigor. Fans of Vision will not be disappointed by this improved

version. Must be isolated from corns of similar maturity days!
 150 seeds **A** \$8.25; 500 seeds **F** \$19.95; 1,000 seeds **G** \$34.55; 2,500 seeds **H** \$67.25; 10,000 seeds **J** \$225.00; 20,000 seeds **K** \$385.00

Quad Sweet



The Quads fit the market demand for heirloom corn taste with modern sweetness

530 Temptress Hybrid (70 Days)
 Temptress is first in the new line of Quad Sweetens. An early bi-colour variety that has strong emergence and a sturdy plant. Temptress has the highest eating quality by combining heritage corn flavour with modern sweetness. This large, 8 in. (20 cm) long, 16 row corn has good snap and ear height. Must be isolated from other corn of similar maturity to avoid cross pollination.

Pkt. 150 seeds **A** \$7.15; 500 seeds **F** \$17.50; 1,000 seeds **G** \$31.50; 2,500 seeds **H** \$60.95; 10,000 seeds **J** \$195.00; 20,000 seeds **K** \$351.00

*Manitoba residents: these items are taxable.

Sugary types (SU)

Sugary types are the original sweet Corn. Full-bodied fresh taste. Cold tolerant. Eat immediately after picking for best flavour.



517 Early Sunglow Hybrid (63 Days)

This classic variety is a favourite where the growing season is short. A yellow sweet type, that cobs big 15-18 cm (6-7 in) on short stalks just 1.2 m (4 ft) tall! Very uniform, neatly filled with about 12 rows of plump, tender kernels.

Pkt. 50 grams **A** \$7.70; 125 grams **F** \$15.35; 250 grams **G** \$24.50; 500 grams **H** \$44.10; 2 kilos **J** \$119.95; 4 kilos **K** \$215.90



520 Peaches & Cream Bi-Colour Hybrid (72 Days)

A perfect blend of white and yellow tender kernels bursting with flavour. This old standby will produce nice size 19 cm (7.5 in) cobs.

Pkt. 50 grams **A** \$7.15; 125 grams **F** \$17.55; 250 grams **G** \$20.75; 500 grams **H** \$37.35; 2 kilos **J** \$155.50; 4 kilos **K** \$279.90

Approximately 50 to 60 corn seeds per 10 grams. 50 gram packet will sow about a 20 m (60 foot) row. 20,000 seeds or 4 kgs (9 lbs) to an acre.

All corn seed is treated with fungicide to control head smut and other diseases. Also enhances germination.

WHITE CORN



566 Eden Hybrid (SH2) (76 Days)

Eden is a game changer as it unites exceptional taste and texture! Very good holding power from picking to market. Bright white kernels with 16-18 straight rows. Slightly tapered 20 cm (8 in.) cobs with good tip fill.

Pkt. 150 seeds **A** \$7.15; 500 seeds **F** \$14.95; 1,000 seeds **G** \$26.90; 2,500 seeds **H** \$60.95; 10,000 seeds **J** \$195.00; 20,000 seeds **K** \$351.00

FEATURE SY CORN



552 Cafe Hybrid (68 Days)

This type combines the sweet creamy flavour of the SE types with the higher sugar content and longer harvest window of the SH2 types to produce exceptionally good corn. Much less sensitive to cold soil than SH2 varieties and do not need to be isolated from SE and SU varieties.

150 seeds **A** \$8.25; 500 seeds **F** \$19.95; 1,000 seeds **G** \$33.95; 2,500 seeds **H** \$67.25; 10,000 seeds **J** \$225.00

3 SISTERS COLLECTION

This growing technique inter-plants this trio because they thrive together. Each contributing something to the planting.



517 Sunglow Corn

The Corn offer support to the climbing Beans.

107 Kentucky Blue Pole Beans

The Beans pull Nitrogen from the air and bring it to the soil for the benefit of all three.

2115 Acorn Squash

The large leaves of the sprawling Squash protect by creating living mulch that shades the soil, keeping it cool and moist and preventing weeds.

600 Three Sisters Planting Combo

Each Collection (3 packs) **A** \$13.95

HYBRID SWEET CORN

Sugar-enhanced types (SE)

Sweet, tender, good flavour. Sweetness varies with climate. Retains flavour longer after picking. Does not have to be isolated.



Improved Fleet Bi-Colour!



535 Trinity Bi-Colour Hybrid (60 Days)

An excellent bi-colour with superb sugary enhanced flavour and creamy, tender-crisp kernels. Cobs are large for an early variety, about 20 cm (8 in) long and are filled to the tips with 14 rows of bright yellow and pearl-white kernels. Prices below with Bodacious.



Improved Amaize!



550 Bodacious Hybrid (75 Days)

As delicious and tasty as it looks. Uniform, supersweet, 18 row cobs are 20 cm (8 in) long. We have received many favourable comments from customers!

Pkt. 50 grams **A** \$7.15; 125 grams **F** \$17.55; 250 grams **G** \$30.15; 500 grams **H** \$54.25; 2 kilos **J** \$155.50; 4 kilos **K** \$279.90



Harvest 15 days earlier by starting ahead of time.

HANDY CORN CUTTER



3415 Lee Corn Cutter*

Over a million sold! Best known tool for removing corn uniformly. Whether cutting whole kernels or creamed corn, the cutter is effective and efficient. The 17" x 2-1/4" x 1/2" frame is hardwood and the metal components are stainless steel. Easy to use and clean.

Each **A** \$21.95; 2 or more \$20.95 each.



3690 Soft Stretch Tie*

A better and easier alternative to vinyl stretch ties, stretchy material expands with the growth of your plant or trees.

Simply pull out from top of ball and cut. Green colour design will blend in with your garden. 30 m (100 ft) Roll.

Each **A** \$12.50; 2 or more \$11.50 each.



Boost Corn!

3258 Corn Fertilizer (25-0-0 + Sulphur)

When corn is 15 cm (6 in), water with this every two weeks for the plumpest, best-tasting corn. Good for cucumbers and melons, too.

227 gram **A** \$12.95; 2 kilos **B** \$45.50

BEETS

BABY CARROTS

Customer Favourite



210 Detroit Dark (58 Days)
 These perfectly round roots have striking deep red flesh that's incredibly sweet. Baby beets make excellent eating. Excellent for cooking and pickling, and tops make tasty greens.

Pkt. 7 grams **A** \$4.80; 25 grams **E** \$7.75; 125 grams **F** \$13.80; 500 grams **H** \$28.95

Excellent Roasted



203 Merlin Hybrid (55 Days)
 Merlin grows quickly to produce tender-fleshed, dark ruby-red, globe-shaped beets. These beets have a high brix content of 12-15%, which means they are sweeter! Harvest at any stage of maturity; either as babies or fully sized up, because these beets hold their flavour and don't get woody or tough.

Pkt. 100 seeds **A** \$4.55; 2,000 seeds **C** \$10.95; 10,000 seeds **F** \$33.95

Feature Beet



205 Bull's Blood (58 Days)
 This heirloom variety will produce great tasting beets and greens. Sweet tasting, candy striped round beets are excellent texture and flavour. Tops are good cooked or also raw as a colourful addition to salads!

Pkt. 7 grams **A** \$4.80; 25 grams **E** \$10.00; 125 grams **F** \$24.70; 500 grams **H** \$42.50



Bigger Pickling Beets!

215 Deep Cylinder (55 Days)
 The roots can be sliced uniformly for delicious pickling beets. At 20 cm (8 in.) long, colour is a brilliant red and flesh is tasty and nicely textured.

Pkt. 7 grams **A** \$4.80; 25 grams **E** \$8.25; 125 grams **F** \$18.95; 500 grams **H** \$44.55



233 Boldor (55 Days)
 Large, dark-golden skinned beets with brilliant yellow interiors. Excellent sweet flavour is delicious when juiced, shredded or roasted. Add the young, tender leaves to your favourite salad! Retains gold colour when cooked.

Pkt. 100 seeds **A** \$5.25; 1,000 seeds **C** \$11.95; 5,000 seeds **E** \$33.95; 10,000 seeds **F** \$61.10

Mild & Sweet



235 Yellow Detroit (55 Days)
 These novel coloured roots turn from orange to gold-yellow when cooked. A very rapid grower that retains its sweet flavour when quite large and is very tender and mild.

Pkt. 100 seeds **A** \$4.80; 1000 seeds **C** \$10.95; 5,000 seeds **E** \$29.25; 10,000 seeds **F** \$52.65

7 grams Beet seed sows about 8 m (25 ft) row. Approximately 50 beet seeds per gram



Baby Sized Pickles

202 Red Ace Hybrid (55 days)
 An improved Scarlet Supreme! Excellent for baby beets! This outstanding, fast growing, sweet flavoured hybrid has smooth, medium size roots of even red colour that maintain their sweet tenderness when larger and older. The short, erect tops are bright, shiny green!

Pkt. 100 seeds **A** \$4.55; 2,000 seeds **C** \$10.00; 10,000 seeds **F** \$29.95



220 Chioggia (58 days)
 This heirloom variety has striking pink and white interior zoning. Has a unique sweet peppery flavour. Delicious raw or cooked.

Pkt. 7 grams **A** \$5.25; 25 grams **F** \$9.95; 125 grams **G** \$23.10; 500 grams **H** \$44.25

Monster Fun for All!

410 Kuroda (65 Days)
 One of our customers' favourites from the past! An improved chantenay type. Despite the outrageous size, which is easily over 500 gm (1 lb) carrots, they are still very tender and sweet. We have had many reports of way bigger than this. A must for bragging rights!

Pkt. 500 seeds **A** \$4.80; 2,500 seeds **B** \$13.25; 5,000 seeds **C** \$23.85

Grow In Containers



405 Mokum Baby Hybrid (56 Days)

If you appreciate fresh carrots, you must try this one! Crisp, yet very easy to munch. Enjoy as a baby carrot or as a full-size 15-20 cm (6-8 in.) tasty treat. Striking deep orange roots with contrasting thick dark green tops. It's still the finest fresh-eating carrot we know!

Pkt. 500 seeds **A** \$4.80; 2,500 seeds **C** \$15.50; 10,000 seeds **E** \$55.80; 25,000 seeds **F** \$75.00



408 Baby Spike Hybrid (55 Days)

Tender fingerling carrots, as sweet and juicy as they come. Mature roots are about 6-10 cm (3-4 in) long and 2 cm (1 in) wide. Excellent for storage, will not lose their flavour or crispness.

Pkt. 3 grams **A** \$4.80; 12.5 grams **D** \$10.95; 25 grams **E** \$19.70; 125 grams **F** \$56.75



Selena from Tetagouche Falls, NB sent in this picture of her 2 lb carrot along with a fantastic letter thanking us for another successful year!

CARROTS

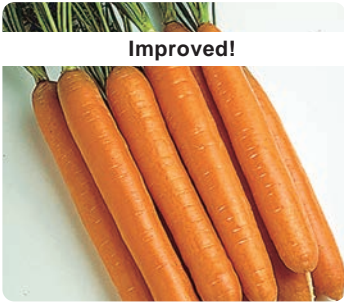

Improved!

415 Sweetness III Hybrid (62 Days)
Without a doubt this is one of the sweetest carrots that you will ever taste. Produces an excellent yield of 15 cm (6 in) smooth shaped roots with a very distinctive shape. High in Vitamin A.
Pkt. 500 seeds **A** \$4.80; 2,500 seeds **B** \$13.25; 10,000 seeds **C** \$47.70; 25,000 seeds **E** \$72.35



Healthier!

435 Healthmaster Hybrid (85 Days)
Roots are huge and have a higher level of beta carotene than other danvers types. It's not unusual for them to grow 30 cm (12 in). Contains 35% more vitamin A than regular carrots.
Pkt. 500 seeds **A** \$4.80; 2,500 seeds **B** \$13.25; 10,000 seeds **C** \$35.75; 25,000 seeds **E** \$82.00



442 Triton (66 Days)
An Emperor type, great for cut & peel, 25 cm (10 in) cylindrical roots with semi-blunt tips. Triton is known for its superb taste and texture. A must have for all gardeners.
Pkt. 500 seeds **A** \$4.80; 2,500 seeds **B** \$13.25; 10,000 seeds **C** \$47.70; 25,000 seeds **E** \$72.00

Colourful Carrots



450 Atomic Red (68 Days)
Large 28 cm (11 in) long tapered roots are a beautiful scarlet colour that gets brighter when cooked. This variety gets its hue from healthful Lycopene, credited for helping prevent several types of cancer.



444 Solar Yellow (65 Days)
The butter-yellow roots are danvers type, 15-18 cm (6-7 in) long. A slightly sweeter alternative to regular orange carrots. Moist and crunchy, they are delicious raw and retain their bright colour when cooked.

Customer Favourites!



440 Scarlet Nantes
One of the sweetest and juiciest carrots. Orange-red roots 15 cm (6 in) long. Wonderful flavour excellent for salads, juicing or for cooking.
Pkt. 7 grams **A** \$4.80; 25 grams **E** \$10.00; 125 grams **F** \$21.25; 500 grams **H** \$46.75



430 Danvers (68 Days)
Best variety for heavy clay soils! Very productive and easy to harvest. Sweet flesh, deep orange in colour. **Best storage variety.** 18 cm (7 in) roots.



420 Royal Chantenay (65 Days)
An excellent winter keeper. A high yielding carrot. Coreless interior is reddish-orange in colour. Ideal for canning and freezing. The quantity of harvest will surprise you.



445 Purple Haze (70 Days)
A unique purple carrot that tapers to a point and reveals a bright orange center when cut. A good size at 25-28 cm (10-11 in) long! The best presentation will be when used raw, since cooking will dissolve the purple colour.

Pelleted Carrot Seed



400 Bolero Hybrid (75 Days)
A great variety for home or market. Very sweet and crunchy. Plus keeps well in storage or in the ground. Roots are bright orange, 14 cm (5 in) long, and slightly tapered, with the typical blunt Nantes tip. Very tasty!



402 Romance Hybrid (70 Days)
Impressive flavour for a summer harvested carrot. High yielding, blunt-tipped, deep orange roots average 15 to 18 cm (6 to 7 in) long. Excellent uniformity with consistently good flavour across all soil types.

Prices for above 2 carrots: Pkt. 250 seeds **A** \$4.35; 1,000 seeds **B** \$9.95; 5,000 seeds **C** \$33.50; 10,000 seeds **D** \$59.00

Approximately 900 Carrot seeds per gram

3175 Sky Rocket Soil Enhancer*
All natural soil enhancer. Helps to balance the soil so plants can jump out of the ground, healthier and happier and grow with less disease and insect problems. Just a handful under each plant and watch them explode! All natural product contains a blend of Kelp, Worm Gold, Activated Charcoal and Betonite Clay. Excellent for houseplants too! Amazing results.

1 kilo **A** \$15.50; 5 kilo **B** \$37.50
250 gr **E** \$5.50

Prices for above 3 coloured Carrots:
Each Pkt. 250 seeds **A** \$4.35; 1,000 seeds **B** \$9.95; 5,000 seeds **C** \$21.05

BROCCOLI

CAULIFLOWER



Most Popular



260 Blue Wind Hybrid (49 Days)

Sure to blow you away! This extra-early maturing broccoli produces impressively large, tightly beaded heads. The handsome, uniform plants sport uniquely coloured, powdery light blue foliage, which stretch above the strong-stemmed, densely packed heads. Produces a continued harvest of very delicious florets!

Pkt. 50 seeds **A** \$4.80; 500 seeds **B** \$17.50; 1,000 seeds **C** \$26.75; 5,000 seeds **D** \$102.50



265 Early Dividend Hybrid (47 days)

The earliest maturing variety that yields "bragging size" quantities with good dark green colour. Excellent flavour and outstanding side-shoot development.

Pkt. 50 seeds **A** \$4.80; 500 seeds **B** \$15.75; 1,000 seeds **C** \$28.35; 5,000 seeds **D** \$90.45

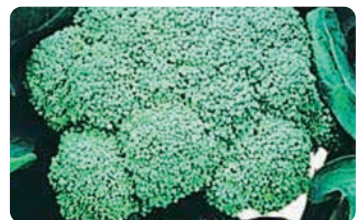

270 Green Goliath (55 Days)

Flavourful blue-green heads are very early for a large broccoli. Also produces tender side shoots over a three-week period. Very high yielding! A perfect pick for fresh eating or freezing.

Pkt. 100 seeds **A** \$4.80; 1,000 seeds **B** \$10.95; 5,000 seeds **C** \$32.95; 10,000 seeds **E** \$59.30

275 Mini Broccoli – Artwork (57 Days)

A unique and beautiful dark green stem mini broccoli. This vigorous early maturing broccolini will produce sweet, tender side shoots over a period of several weeks. The small main head should be harvested early to encourage production of side shoots. Home gardeners can make the art of gardening and cooking come alive with this delicious, long-yielding variety!

Pkt. 50 seeds **A** \$4.80; 250 seeds **B** \$18.95; 500 seeds **C** \$34.10; 1,000 seeds **D** \$55.25

BRUSSEL SPROUTS



280 Hestia Hybrid (90 Days)

These heavy-bearing, sturdy, straight plants have bright green 2.5 cm (1 in) sprouts with a delicious yellow interior with a higher brix (soluble sugars) than other hybrids. If frost strikes in the midst of your harvest, it should be no problem. Frost sweetens the flavour!

Pkt. 50 seeds **A** \$5.50; 500 seeds **B** \$30.95; 1,000 seeds **C** \$55.70



455 Majestic Hybrid (55 days)

One of the earliest varieties of cauliflower; more heat and drought tolerant than other varieties. The creamy white heads average 6 to 8 inches across.

Pkt. 50 seeds **A** \$5.45; 500 seeds **B** \$26.75; 1,000 seeds **C** \$42.35; 5,000 seeds **E** \$159.95



466 Amazing Hybrid (68 days)

Harvest as a "baby head" or when fully mature. White heads are covered by large wrapper leaves that protect them from sun, heat and cold. If you've had trouble growing cauliflower, this variety is an excellent choice.

Pkt. 75 seeds **A** \$5.45; 500 seeds **B** \$21.95; 1,000 seeds **C** \$40.25; 5,000 seeds **E** \$162.00



460 Cheddar Hybrid (68 days)

This amazing cauliflower is the most attractive and good-for-you variety. Averaging 10 - 18 cm (4-7 in) across. A beauty!

Pkt. 25 seeds **A** \$8.25; 100 seeds **B** \$36.75; 500 seeds **C** \$116.95



465 Depurple Hybrid (65 days)

Buttery-sweet, nutty nuanced lavender florets. Adds magical colour and savoury rich flavour served fresh, broiled or sautéed. To retain the colour, sprinkle with vinegar or lemon juice before steaming, roasting, or sautéing.

Pkt. 25 seeds **A** \$7.95; 100 seeds **B** \$26.75; 500 seeds **C** \$82.00



470 Puntoverde Cauliflower Hybrid (78 Days)

A vigorous dark green Romanesco hybrid. The curd is very deep with more rounded points less likely to break or bruise during harvesting. Produces well under stressful weather conditions.

25 seeds **A** \$8.00; 100 seeds **B** 25.75; 200 seeds **C** \$45.75

MAGNETS FOR AMAZING RESULTS!

Improve water for the garden, your pets and you!



WATER-MAG – WATER ACTIVATOR!

Make water from your tap as natural as rain! Built-in magnetic devices polarize clusters of water molecules and break them apart, neutralizing any chemicals the water contains—such as salt, chlorine and fluoride. North pole magnetized water can be beneficial to all. It lowers the surface tension of the water making it more absorbable by people, plants and animals! North pole treatment causes an alkaline action that is beneficial to us; remember an acidic environment in the body is synonymous with disease and ill health, often the body is acidic and north negative will help normalize natural alkaline pH.

3745 Water-Mag Water Activator*

Attach this to your main waterline in your basement or onto your garden hose. Will help prevent minerals from clogging lines. Excellent for use in restaurants, hotels, ice-maker and greenhouses. Adapts to 1/2 inch, 3/4 inch and 1 inch pipe sizes. No filters to clean or replace.

Each **A** \$75.95; 2 or more \$69.95 ea.

*Manitoba customers: these items are taxable

GIFT CERTIFICATES

Give the gift that keeps on growing! Gift certificates never expire and can be used in-store or online for any of our products. Purchase in-store, online or by mail order.

MELONS



1200 Aphrodite Hyb. (72 Days)
Slightly larger, Athena type melon. Early maturing with large 2.5-3.2 kg (6-7 lb) melons with salmon coloured flesh, firm, sweet and stores very well!

Pkt. 15 seeds **A** \$5.50; 100 seeds **B** \$27.95; 200 seeds **C** \$50.30; 500 seeds **D** \$89.50



1201 Muskmelon HalonaHybrid (73 Days)
Succulent bright orange flesh and amazing flavour. This globe-shaped fruit sets heavily on strong, disease resistant plants. Melons reach 15 cm (6 in) in diameter, weighing in around 2-2.5 kg (4-5 lbs).

Pkt. 15 seeds **A** \$5.50; 100 seeds **B** \$17.50; 200 seeds **C** \$30.15; 500 seeds **D** \$59.95



1244 Quetzali (83 Days)
Short vines with 4-5.4 kg (9-12 lb) watermelons with a sweet, smooth texture and refreshing flavour. Early maturing fruit and excellent for growing in patio containers.

Pkt. 15 seeds **A** \$4.95; 50 seeds **B** \$8.75; 100 seeds **C** \$15.75; 200 seeds **D** \$31.50



1230 Shiny Boy Hybrid(75 Days)
Shiny Boy boasts very dark red flesh with the perfect blend of sugar and crunch. Wonderfully aromatic, true watermelon flavour! You will love it!

Pkt. 10 seeds **A** \$5.50 25 seeds **B** \$12.15; 50 seeds **C** \$21.85; 100 seeds **D** \$43.75



1204 Minnesota Midget (65 Days)
This small, early heirloom was introduced in Minnesota in 1948. They have sweet, orange flesh that's edible right to the rind! Compact, 3-4-foot vines produce good yields.

Pkt. 15 seeds **A** \$4.95; 100 seeds **B** \$13.25; 500 seeds **C** \$32.95



1221 Mini Love Hyb. (70 Days)
Early personal sized watermelon with bright red, crisp flesh. This hybrid is compact and can produce up to six 3-4 kg (7-9 lb) fruit per plant. The fruit are nicely striped, shiny and hold up well after harvest!

Pkt. 10 seeds **A** \$8.75; 25 seeds **B** \$20.10; 50 seeds **C** \$36.20



1225 Sweet Beauty Hyb. (72 Days)
This AAS winner will let everyone enjoy Watermelon this summer! The robust plants will consistently produce sweet, crisp Melons with fruit size of 2.5-3 kg (5-7 lbs). Very early producer!

Pkt. 10 seeds **A** \$4.95 25 seeds **B** \$13.25; 50 seeds **C** \$33.85; 100 seeds **D** \$47.70



1240 Mambo Hybrid (75 Days)
Will grow and yield well even in cool conditions! The dark green rind and deep red flesh holds well and doesn't over ripen. Each 22 cm (9 in) fruit will weigh about 5 kg (11 lbs) at maturity. A smaller seed cavity means an almost seedless watermelon.

Pkt. 10 seeds **A** \$8.75; 50 seeds **B** \$38.00; 100 seeds **C** \$68.40



1207 Honeydew Snow Mass Hybrid (75 Days)
An improved honeydew! Hard white smooth rind with high sugar content. Small seed cavity. Early enough for short season areas. Pick when it turns to a cream colour.

Pkt. 15 seeds **A** \$6.00; 100 seeds **B** \$23.40; 200 seeds **C** \$42.10; 500 seeds **D** \$77.25



1205 Sugar Cube Hyb. (80 Days)
A small melon with a whopping big taste! Coarsely netted, round, 1 kg (2 lb) fruit with juicy, deep orange flesh with a tremendous 14% sugar content. Add an extended shelf life and you can keep these sweet, rich morsels close at hand for a personal-sized treat anytime.

Pkt. 15 seeds **A** \$5.50; 100 seeds **B** \$23.40; 200 seeds **C** \$34.50; 500 seeds **D** \$82.85



1235 New Queen Hyb. (61 Days)
Unique colour with a flavour that will impress you! Bright orange flesh that is so sweet and crispy you may never grow regular melons again. Nice size, with fruit reaching 3 kg (6 lbs).

Pkt. 10 seeds **A** \$5.50; 25 seeds **B** \$13.25; 50 seeds **C** \$23.85; 100 seeds **D** \$47.70

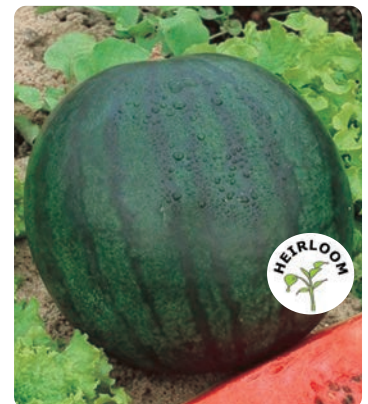

1245 Sugar Baby (75 Days)
Ideal for home gardens. The plants will produce loads of small fruit 20 cm (8 in). Very sweet, firm, red flesh.

Pkt. 3 grams **A** \$4.95; 12.5 grams **D** \$8.75; 25 grams **E** \$15.75; 125 grams **F** \$22.10

SPINACH



Loads of Iron!

2015 Vancouver Hybrid (42 Days)

An improved Catalina! Rich dark-green leaf colour on upright large plants. Very slow bolting. Tasty!

Pkt. 500 seeds **A** \$4.55; 5,000 seeds **B** \$15.90; 15,000 seeds **C** \$29.95



2025 Avon Hybrid (44 Days)

Quick-growing, superb flavour spinach that is very bolt tolerant. Large, tender, dark green, savoy spinach variety.

Pkt. 500 seeds **A** \$4.55; 5,000 seeds **B** \$15.90; 15,000 seeds **C** \$29.95

Use As Baby Greens



1371 Imperial Green Asian Spinach (45 Days)

Tasty, succulent, deep green arrow-shaped leaves on long, upright stems. Slow to bolt and produces a higher quality leaf. Make a wonderful Spinach salad, or mix the leaves with lettuce and other greens.

200 seeds **A** \$4.55; 1,000 seeds **B** \$7.65; 5,000 seeds **C** \$34.45

GREENS



Tasty & Ornamental

895 Ruby Red Orach (40-55 Days)

Spinach-like plant, but of a different colour! The velvety leaves are a bright fuchsia, with bright magenta stems, making it pretty enough to be a houseplant. Has a spinach like flavour. Will grow 60 to 90 cm (3 to 4 ft) tall, but can be picked at any stage!

Pkt. 100 seeds **A** \$4.55; 500 seeds **B** \$7.65



More Swiss Chard - P. 20

240 Perpetual Spinach (Swiss Chard) (50 Days)

Extremely resistant to bolting, so you can feast on these dark green succulent leaves and white stalks the entire summer. Use raw in salads, or steamed.

Pkt. 5 grams **A** \$4.25; 25 grams **E** \$7.75; 125 grams **F** \$20.00

Pelleted Seeds for Accurate Sowing & Less Thinning.



911 Summercrisp Muir (50 Days)

An extremely heat tolerant variety that is slow to bolt. A Batavian type, with light green, extra-wavy leaves that form dense heads at a small size and can be harvested as a mini or left to grow into large, heavy, full-size heads. Crisp with excellent flavours.

Pkt. 100 pellets **A** \$5.80; 500 pellets **D** \$21.15; 1,000 pellets **E** \$38.05; 5,000 pellets **F** \$112.95

LETTUCE

Precision Multi-Pellets

Pelleted seed with 4 or more seedlings per pellet. Perfect for growing in containers for a year-round supply!



996 Arugula (40 Days)

Unique flavour – peppery and sharp, comes to life in this easy to plant variety for garden and container! Pick them as young as you like for gourmet baby greens, or let them mature. Precision multi-pellets. Prices below



900 City Garden Mix

Here's the perfect baby lettuce mix! A blend of red, light green, and dark green lettuce leaves (both smooth and ruffled) grow together in this pretty salad combo. Loaded with vitamins! Precision multi-pellets.



902 Global Gourmet Mix

Enjoy multiple crops from one planting. A combination of red and green leaf lettuces and asian greens that are both colourful and ideal for salads and stir fry. Precision Multi-Pellets.

Prices for each of the above 3 Mixes

Pkt. 10 pellets **A** \$5.25; 50 pellets **B** \$15.75; 100 pellets **C** \$28.35



926 Butterhead Mirlo (52 Days)

Large, creamy green butterhead is early for its size. Soft buttery outer leaves & dense, tender hearts are excellent for fresh salad.

Batavia/Summer Crisp Type

Easy to grow, tolerant of hot weather and harvestable from baby to full size! Crisp like romaine, but sweet and juicy without bitterness.



910 Muir (50 Days)

Extremely heat tolerant and one of the slowest to bolt. The light green, extra wavy leaves form dense heads at a small size and can be harvested as a mini or left to bulk up into large, heavy, full-size heads. The leaves are crisp and have excellent flavour. Price below with Magenta.



912 Magenta (48 Days)

Red summer crisp with good flavour! Shiny, slightly puckered, red-tinged leaves form a whorled, conical head with a crispy, green heart. Ideal for spring and summer planting. Tolerant to bolting, tip burn, and bottom rot. High resistance to downy mildew.

Prices for both Muir or Magenta

Pkt. 50 seeds **A** \$4.80; 250 seeds **B** \$13.25; 500 seeds **C** \$23.85



951 Head Lettuce Summertime (70 Days)

A heat resistant/bolt tolerant crisp Head Lettuce. Summertime produces solid heads with better colour, better leaf texture and better quality. Heads almost never become bitter.

ROMAINE TYPES

LETTUCE

FEATURE GREENS

Feature Romaine



966 Valley Heart (75 Days)
Fast maturing, uniform variety that is well-suited to use in a chopped salad or for lettuce cups. The medium green Romaine colour combined with large, slightly savoyed leaves just add to the overall appeal of this variety. Valley Heart also has good bolting tolerance.

Pkt. 250 seeds **A** \$4.15; 1,000 seeds **B** \$14.30; 5,000 seeds **C** \$35.50



960 Romulus (70 Days)
A must for your salads! This new romaine type will produce rich glossy green leaves with beautiful contrasting blanched interior. Heads are 30 cm (12 in) tall with slightly savoyed leaves.

Pkt. 500 seeds **A** \$4.25; 12.5 grams **D** \$9.75; 25 grams **E** \$17.55; 125 grams **F** \$59.95

Butterhead Types



925 Buttercrunch (60 Days)
An outstanding type of lettuce with the crispiest, crunchiest leaves. A longtime proven variety!

Pkt. 2 grams **A** \$4.25; 12.5 grams **D** \$9.95; 25 grams **E** \$14.70; 125 grams **F** \$23.50



970 Esmeralda (53 Days)
An excellent buttercrunch type bred for both disease-resistance and bolt tolerance! Superior firm heads are both crispy and sweet with a very attractive rich green colour. Loaded with vitamins!

Pkt. 250 seeds **A** \$4.25; 12.5 grams **D** \$9.95; 25 grams **E** \$17.90

Head Type



950 Summertime (70 Days)
A heat resistant/bolt tolerant crisp head lettuce. Summertime produces solid heads with better colour, better leaf texture and better quality. Heads almost never become bitter.

Pkt. 250 seeds **A** \$4.95; 1,000 seeds **B** \$16.10; 5,000 seeds **C** \$35.50

Leaf Types



Heat Resistant



915 Simpson Elite (48 Days)
An improved black seeded Simpson type. Very quick to grow and extremely bolt resistant. This will extend your harvest to over 45 days or more, giving ample fresh Lettuce from the garden.

Pkt. 250 seeds **A** \$4.25; 5,000 seeds **D** \$12.25; 25,000 seeds **E** \$55.15

Approximately 900 Lettuce seeds per gram



Nice In Flower Beds



920 Red Sails (45 Days)
A unique plant, looks great in the flower garden as an accent as well as the vegetable garden. Features bronze-red, crinkled leaves, higher in vitamins than head lettuce.

Pkt. 250 seeds **A** \$4.25; 5,000 seeds **D** \$11.25; 25,000 seeds **E** \$33.00



909 Green Ice (45 Days)
Green Ice is one of the crispest, most satisfying loose-leaf lettuces you can grow. The leaves are glossy, dark green, and savoyed, giving them extra-crunchy texture in every bite. Early yet lasts well into summer, thanks to superior heat tolerance!

Pkt. 250 seeds **A** \$4.25; 1,000 seeds **B** \$9.95; 5,000 seeds **C** \$28.95



990 T&T's Lettuce Mix
A delicious mix of 10 different Leaf and Head Lettuces. Start in a container indoors, move outdoors when weather warms.



991 Mesclun Mix
A delightful mix of tasty greens that make an attractive and tasty salad mix! Also makes a very eye-appealing show in your garden with an array of coloured edible greens.



995 Arugula (41 Days)
This tasty salad green does not require any type of special care or attention for summer long production. Peppery-sweet flavour. Also known as "Roquette".

Prices for each of the above 3 varieties

Pkt. 2 grams **A** \$4.25; 12.5 grams **D** \$12.25; 25 grams **E** \$22.05

CHICORY-ENDIVE



975 Escarole Natacha (48 Days)
Big heavy heads with abundant tender leaves and creamy, blanched hearts. Use as a base for salads in place of lettuce, or wilted in a variety of delicious recipes. Prices below with #992

992 Endive Benefine (48 Days)
Also known as Frisée- ruffled head of thin, light-green leaves, deeply cut and toothed. At maturity, its heart blanches to reveal creamy, tender sweet leaves ideal for gourmet salads.

Pkt. 100 seeds **A** \$4.55; 500 seeds **B** \$10.75; 1,000 seeds **C** \$19.35

BASIL

Considered one of the healthiest herbs, Basil provides vitamin A, Iron, Calcium, Manganese, Magnesium, Vitamin C and Potassium, and contains Beta-Carotene a powerful antioxidant.

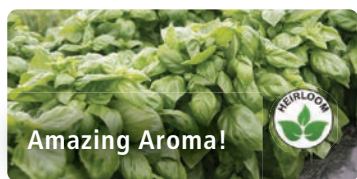

885 Everleaf Genovese (65 Days)
Productive, compact, and slow-bolting! Long, glossy and cupped leaves with classic Genovese basil aroma. A very compact plant that produces high yields of leaves and tips. Perfect for pesto and sauces. Robust 45-60 cm (18-24 in) plants!

Pkt. 25 seeds **A** \$4.55; 250 seeds **B** \$19.95; 500 seeds **C** \$35.90



849 Sweet Basil
Large leaves, sweet flavouring for many foods. Mmm!

Pkt. **A** \$4.00; 5 grams **B** \$8.75; 25 grams **C** \$14.55



855 Dolce Fresca Italian Basil
Sweet tender leaves. Use the leaves as you would any Genovese basil and we hear it makes an excellent pesto!

100 seeds **A** \$4.00; 500 seeds **B** \$8.75



851 Mammoth Basil
Huge leaves, a stronger, fuller flavour than sweet basil. Perfect for sauces, pesto and even fresh on a sandwich. Try growing this Basil on a sunny windowsill, it loves filtered light.

Pkt. **A** \$4.00; 5 grams **B** \$8.75; 25 grams **E** \$14.50

FENNEL



863 Antares (68 Days)
This is an All-American Selection winner and is the first fennel to ever be selected as a winner for its' amazing flavour compared to other fennel varieties. Pure white, round bulbs with dark green fern-like foliage. Resists tip burn and is slow to bolt. Very sweet licorice/anise flavour. 50 seeds **A** \$4.35; 250 seeds **B** \$9.95; 500 seeds **C** \$17.90

863 Antares (68 Days)
This is an All-American Selection winner and is the first fennel to ever be selected as a winner for its' amazing flavour compared to

PET GREENS



Not included in the herb special.
890 Renee's Cat Grass
Pet cats, rabbits and birds naturally crave and enjoy eating greens. Plant this fancy blend of four organically grown grasses just for them. It will satisfy this need and deflect them from eating your houseplants. This nutritious mix is tender, sweet and easy to digest. Fresh greens are a natural breath freshener and provides beneficial roughage that will aid your pets digestion and prevent hair balls.

20 gram package **A** \$4.95
2 or more \$4.50 each.

CELERY



506 Tango
Smooth, non-stringy stalks have a big celery crunch. Vigorous plants with fresh, tender stalks that are super-crunchy and sweet.

Pkt. 100 seeds **A** \$4.00; 1,000 seeds **B** \$12.25

CILANTRO



Slow Bolting



844 Cilantro (Coriander)
Used medicinally and as a flavouring for meats, pickles and Mexican dishes.

Pkt. **A** \$4.00; 25 grams **E** \$8.75; 125 grams **F** \$17.50

LAVENDER



Fragrant



810 Lavender Lady (Perennial)
Easier to germinate than other varieties of lavender. Uniform plants have a scented foliage and will produce loads of blue flowers on 30 cm (12 in) spreading plants. The flowers attract bees but deer and rabbits tend to leave this plant alone.

Pkt. 25 seeds **A** \$4.95; 250 seeds **B** \$22.95; 500 seeds **C** \$41.30

PARSLEY



1510 Italian Parsley (75 Days)
Plain dark green leaves, but a much more pronounced flavour than the standard curled type.

Pkt. 3 grams **A** \$4.00; 12.5 grams **D** \$7.75; 25 grams **E** \$13.95; 125 grams **F** \$18.75



1500 Fine Moss Curled (70 Days)
Excellent for garnishing cold plates or for flavouring soups.



1520 Turnip Rooted Parsley (90 Days)
This slender 15 cm (6") parsnip-like roots with their delicate Parsley taste have been used for flavouring soups and stews. This variety stores very well through the winter. A great dual purpose plant as the coarse leaves can be used as a garnish.

Pkt. 3 grams **A** \$4.00; 12.5 grams **D** \$7.75; 25 grams **E** \$13.95; 125 grams **F** \$18.90

Herbs SPECIAL

Any 5 packets or more of size "A" your choice from these 2 pages

PRICING \$3.65 each

Herbs grow great indoors on a windowsill for freshness all year round!

Create a Culinary garden!

- Great companions
- Add to pots and landscaping
- Flavour foods
- Aromatherapy
- Repel insects



854 Chives – Garlic (Perennial)

A tasty perennial that combines the flavour of garlic and onions. Lovely white flowers in late summer.

Pkt. **A** \$4.00; 10 grams **C** \$7.80



838 Sorrel

The tender, fresh green leaves grow to about 20 cm (8 in) long and have an intense lemony flavour. Use sparingly in salads or generously in soups, stews and sauces, especially with fish.

Pkt **A** \$4.00; 1,000 seeds **B** \$7.65



Repels Mosquitoes

832 Catnip

Not just for cats. Like so many herbs, it also has uses in food and medicine, whether used fresh or dried. Catnip will repel all varieties of mosquitoes! An essential oil found in catnip, is actually more effective at repelling these pests than Deet (the chemical used in most commercial insect repellents)

Pkt. **A** \$4.00; 2 grams **B** \$7.65



Attracts Bees

831 Borage (Bee Bush)

A medicinal herb with edible leaves and flowers. Bright blue star shaped flowers accent ice cream, salads, you name it! Growing borage will provide you with leaves that taste like cucumbers. A must for the butterfly garden and will bring pollinators to your garden.

1 gram Pkt. **A** \$4.00; 25 grams **B** \$8.80



Repels Mosquitoes

830 Lemon Balm (Perennial)

Rub leaves between palms of your hand and rub the oils on exposed skin for long-lasting mosquito protection. Steep fresh or dried leaves in hot water for a healing tea! Perennial.

Pkt. **A** \$4.00; 2 grams **B** \$8.80



845 Spearmint (Perennial)

Young leaves can be used in sauces, jellies, summer drinks and mint tea.

Pkt. **A** \$4.55; 2 grams **B** \$10.50



858 Peppermint (Perennial)

Both the leaves and flowers can be dried for teas or use in stews and sauces. Mint flowers are edible, and highly attractive to bees and other pollinators. Repels spiders and mice.

Pkt. **A** \$4.35; 2 grams **B** \$9.95



856 Poppy Seed

These pretty flowers produce large pods loaded with tasty seeds. Ideal for baking cakes, breads, etc. Flowers in mixed colours. (Seed count – 2,000 seed per gram).

Pkt. **A** \$4.00; 5 grams **B** \$6.95; 25 grams **E** \$19.95



857 Jambalaya Okra (50 days)

An extra-early maturing variety that boasts very compact plant with high yields of shiny, dark green pods. An ideal choice for smaller home gardens. Excellent in homemade soups, stews and relishes.

Pkt. **A** \$4.35; 10 grams **C** \$16.75

860 Carmine Splendor Okra Hybrid (51 Days)

Beautiful, 5-pointed pods are deep red when small, fading to a lighter red/pink when larger. They turn a light green when cooked. Fast maturing with a mid to late summer harvest season. Attractive pink-tinted edible flower. Okra pods, leaves and flowers are edible.

15 seeds **A** \$3.75; 50 seeds **B** \$9.95



835 Oregano Italian (Perennial) Upright sprawling culinary herb that also attracts pollinators.

Pkt. **A** \$4.00; 2 grams **B** \$7.65



836 Rosemary (tender perennial)

An aromatic herb used in soups, meat stocks and potato dishes. Bring into a sunny window in winter.

Pkt. **A** \$4.00; 2 grams **B** \$14.50

836 Rosemary – Multi Pellet (5 seeds in each pellet)

10 pellets **C** \$5.25; 50 pellets **D** \$15.95; 100 pellets **E** \$29.40



846 Sage

Favourite for meat and poultry dressing recipes. Relaxing aroma!

Pkt. **A** \$4.00; 10 grams **C** \$10.95



847 Summer Savory

Compact, fragrant and easy to grow.

Pkt. **A** \$4.00; 5 grams **B** \$7.65

837 Thyme – English

Dried leaves useful for seasoning fish, meats, vegetables and poultry.

Pkt. **A** \$4.00; 2 grams **B** \$8.35

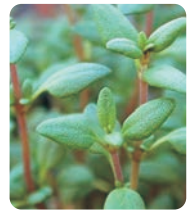

868 Thyme – Creeping (Perennial)

Aromatic low growing bush 5-7 cm (2-3 in.) which is ideal for rockeries, borders or pathways. A must for meat and fish dishes. The youth herb (anti-oxidant)!

Pkt. **A** \$4.00; 2 grams **B** \$8.80

KALE

SWISS CHARD



866 Scarlet Kale Hybrid (30-55 Days)

Broad, frilly, dark purple leaves grow on 90 cm-1 m (2-3') tall, upright stalks. An open-pollinated variety that is very slow to bolt. Scarlet has great flavour either as baby leaf or mature kale, and the flavour improves after a frost. A handsome ornamental and a very edible kale to try in your vegetable garden.

Pkt. 50 seeds **A** \$4.80; 500 seeds **C** \$15.75; 1,000 seeds **D** \$28.35



859 Prizm Hybrid (30-55 Days)

Produces short, ruffle edged leaves that are content to be grown in containers as well as in garden beds. Easy-to-maintain, almost stemless stalks are quick to re-leaf so harvest early and often for a continual supply throughout the season. Tender enough to enjoy in fresh salads but also hold up well when cooked.

Pkt. 25 seeds **A** \$4.95; 150 seeds **B** \$10.85; 500 seeds **C** \$21.75



High Resistance To Bolting

1378 Silverado Baby Swiss Chard (60 Days)

Produces relatively compact plants that have heavily savoyed, deep, dark green leaves with bright white stems. A taste test favourite!

100 seeds **A** \$4.25; 500 seeds **B** \$8.35; 1,000 seeds **C** \$15.05



Very Ornamental

245 Bright Lights (40 Days)

Grow a rainbow of colours! Yellow, gold, orange, pink, violet, green, or striped, in addition to the standard white or red. Featuring an improved tenderness and a milder chard flavour. Lovely in the landscape. Leaves make very unique cabbage rolls! Ht. 45 cm (18 in) and spreads about 40 cm (16 in).

Pkt. 100 seeds **A** \$4.25; 500 seeds **B** \$12.25; 1,000 seeds **C** \$22.50



843 Kale Dwarf Siberian

Slow to bolt. Plant produces very flavourful dark green kale leaves. Used fresh in salads and on sandwiches. Also can be steamed or used in stir fries.

Pkt. **A** \$4.35; 10 grams **B** \$8.80



841 Kale Blue Curled (35 – 80 Days)

Highly decorative curly fringed leaves that are delicious & nutritious. Relished by many for boiling as greens or chopped fresh like lettuce for salads, when young.

Pkt. **A** \$4.35; 10 grams **B** \$7.65

KOHLRABI



870 Early White Vienna (55 Days)

A mild, delicious vegetable that tastes like a cross between turnip and cabbage. Great cooked or raw, in slaws, dips, as well as cubed, steamed or sauteed. Greens are also edible and more tender the sooner you eat them after harvest!

Pkt. 3 grams **A** \$4.15; 25 grams **E** \$8.50; 125 grams **F** \$17.80

875 Early Purple Vienna (55 Days)

A mild, delicious vegetable that tastes like a cross between turnip and cabbage. Great cooked or raw, in slaws, dips, as well as cubed, steamed or sauteed. Greens are also edible and more tender the sooner you eat them after harvest!

Decorative Row Markers



Metal Row Markers*

Spruce up your back yard garden with these beautiful and trendy metal garden markers. These garden stakes are laser cut and available in 2 sizes for a variety of different plants. The price is per stake. Please choose the item number from options below.

12 inch markers:

- 5801 Beet
- 5802 Basil
- 5803 Carrot
- 5804 Cucumber
- 5805 Onion
- 5806 Bean
- 5807 Radish
- 5809 Lettuce

12 inch Size **A** \$8.95 each

18 inch markers:

- 5852 Corn
- 5853 Pepper
- 5854 Potato
- 5855 Peas
- 5856 Tomato
- 5857 Zucchini

18 inch Size **A** \$11.95 each



Grow In Containers



852 Kale Storm Mix

The very first all kale salad mixture contained within a single pellet including frilly leaved types, purple types and blue types. Unique multi-seeded pellets each contain at least 5-7 different seeds allowing for easy production of multi-leaf mixes or baby leaf greens in a small container.

Pkt. 10 pellets **A** \$5.25; 50 pellets **B** \$14.25; 100 pellets **C** \$25.65

When packed by weight Kale has approximately 250 seeds per gram



5966 Gourmet Herb Stripper*

The new gourmet herb stripper allows you to easily remove the herb content from the stem in seconds. Be it parsley, oregano, rosemary, thyme or even leafy vegetables like kale, collards and chard, it leaves no leaves behind! With its round edge to cut leaves, this tool becomes an all-in-one must-have when cooking with fresh herbs and salads.

Each **A** \$10.95; 2 or more \$10.15 each



ONIONS - FOR ZIP AND ZEST!

Spanish Types



Great For Storing

1425 Candy Hybrid (85 Days)
An outstanding new introduction that will allow anyone to grow a perfect mild sweet onion! Candy will produce early and big. One of the years must-plant varieties. Also excellent as a storage type.

Pkt. 150 seeds **A** \$4.55; 1,000 seeds **B** \$19.95; 5,000 seeds **E** \$61.50; 20,000 seeds **F** \$186.95



1478 White Cloud Hybrid (115 Days)

Vigorous tops and strong roots make this onion extremely productive. A brilliant white color with a globe shape. Excellent home garden variety.

Pkt. 150 seeds **A** \$4.95; 1,000 seeds **B** \$18.95; 5,000 seeds **E** \$60.25; 20,000 seeds **F** \$184.75

Scallions



1400 Evergreen White (60 Days)
This non-bulbing, easy stripping onion has beautiful white colour, upright stalks and slender dark-green stems.

3 grams **A** \$4.55; 12.5 grams **D** \$8.95; 25 grams **E** \$16.10; 125 grams **F** \$26.75

Red Type



1490 Red Carpet Hybrid (116 Days)

Magnificent magenta interior rings make this an especially gorgeous red onion. Tight bulbs that store extremely well. Rich colour and flavour!

Pkt. 150 seeds **A** \$4.95; 1,000 seeds **B** \$21.25; 5,000 seeds **E** \$74.95

Kelsae Onion Offspring



1450 Exhibition Spanish Onion Hybrid (110 Days)

Finally we have it back-or very close-"Kelsae" onion is one of the parents of "Exhibition". This popular heavyweight variety is grown for agricultural competitions and its incredible sweet flavour. Highly prized for its record size and weight, "Kelsae" fans will find this as the closest variety available for the coming season.

75 seeds **A** \$4.95; 500 seeds **B** \$13.25; 1,000 seeds **C** \$24.05; 5,000 seeds **E** \$71.50

FEATURE SPANISH SWEET, MILD & BIG!



1454 Ailsa Craig Sweet Spanish Onion (110 Days)

This English heirloom is a blue ribbon winner! This huge 1 kg (2 lb), 15-20 cm (6-8 in), straw yellow globe onion is amazingly sweet and firm for its size. A long-day sweet Spanish type, Ailsa Craig is reported to be a longer storing onion than other sweet Spanish types. Perfect for burgers and salads.

Pkt. 75 seeds **A** \$4.55; 1,000 seeds **B** \$9.00; 2,000 seeds **C** \$16.20; 5,000 seeds **E** \$23.40; 25,000 seeds **F** \$82.75

LEEK



880 Large American Flag(120 Days)

Also called the gourmet onion because of its mild, delicate flavour. Delicious in stir-fry, soups, stews and salads.

Pkt. 3 grams **A** \$4.15; 12.5 grams **D** \$9.75; 25 grams **E** \$17.55

PARSNIP



1575 Hollow Crown (110 Days)

A fine textured, tasty parsnip with a delicious nutty flavour. Leave the roots in the ground as late as frost permits in fall.

Pkt. 7 grams **A** \$4.25; 25 grams **E** \$8.35; 125 grams **F** \$16.75; 500 grams **H** \$26.75

Feature Cooking

1405 Genesis Hybrid (100 Days)

This excellent storage type will give you an abundant crop of yellow, pungent tasting cooking onions! Keeps up to 6 months after harvest. Clean golden brown colour on uniform, medium to large globe shaped onions!

Pkt. 150 seeds **A** \$4.55; 1,000 seeds **B** \$15.75; 5,000 seeds **C** \$41.25

Approximately 300 onion seeds per gram

Feature Bags



3764 Burlap Bags*

Choose burlap for storing vegetables just picked from your garden! Also works excellent for storing bulbs and tubers over winter. Breathable and re-usable! Size 44 cm x 73 cm (20" x 30")

Pak/4 bags **A** \$10.95; 2 or more paks \$9.95 each

*Manitoba customers: these items are taxable

PEAS



1625 Green Arrow (67 Days)
The pods are on the top 25 cm (10 in) of the plant. Stays sweet an extra-long time! Dark green pods grow in pairs at the top of the plant for easy picking. 9 to 11 perfectly plump peas per long, well-filled pod. Resists wilt and mildew. Most can be harvested 18-20 days after they flower. Delicious fresh and cooked. Perfect for canning and freezing.



1630 Lincoln Homesteader (68 Days)
There is no sweeter, more delicious pea than this one! Proven heat and drought tolerant, this Heirloom pea will provide you with vigorous, fast growing vines. The easy-to-pick, deep green 11 cm (4 in) pods contain 8-9 sweet, rich green peas. Superior flavour that holds well, fresh, refrigerated, or frozen, this has become our variety-of-choice for prolific peas for fresh eating and stocking up for the off-season so you will never run out of these sweet things!

Sizes and prices as indicated below
The package size "A" is included in our quantity break pricing.



1620 Parsley Pea Hyb. (30+ Days)
Parsley peas are different from other peas because they produce tender and delicious, multi-branched, leafy edible tendrils that resemble parsley yet taste like peas. Semi-trailing plants grow to 1 m (2-3 ft) tall, and will also produce pea pods that are similar to snap peas. Harvest whole plants at 20-30 cm (8-12 in) tall, or snip just the tendrils to allow the plants to mature and produce peas. Add parsley pea tendrils to salads, sandwiches, or toss into stir-fries at the last minute. Pricing and sizes the same as #1607 below.

PEA PRICING

50 grams	A	\$4.70	500 grams	H	\$12.30
125 grams	F	\$5.10	2 kilos	J	\$35.50
250 grams	G	\$7.80	4 kilos	K	\$63.90

Save! Buy any two (or more) A size \$3.95 each

Edible-Pod Types

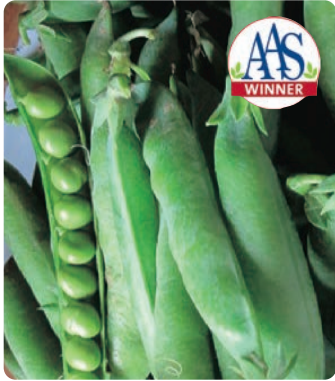

1650 Mr. Big (55 Days)
An All-America Selection. Extra large pods (easy-to-shell) that are 11 cm (4.5 in) long and contain 8 to 10 plump, sweet tasting peas, it also yields like crazy. We suggest you support this vigorous grower. Trials showed that they would climb 2 m (6 ft) when supplied a trellis. If left unsupported they only got 1 m (3 ft) high. Great sweet flavour makes Mr Big ideal for eating fresh, but it also is an excellent freezing Pea!



1600 Snow Pea Dwarf Sugar (65 Days)
Tender, fleshy, edible pods with a wonderful sweet flavour. Perfect for stir-fries and salads.



1605 Super Sugar Snap (66 Days)
Super Sugar Snap delivers the crisp, sweet flavour of sugar snap, but its pods are plumper. Sweet, luscious and tender pods are delicious eaten raw from the garden in salads and stir-fries. Strong robust plants grow 1.5 m (4 1/2 ft). Outstanding yield!



1607 Snak Hero Hyb. (65 Days)
Slender 4" long pods have the straight and elongated appearance of a succulent green bean but the surprising taste and texture of a snap pea. 18-24" vines can be grown with or without support. Harvest regularly to increase harvest window.
Pkt. 50 grams **A** \$4.70; 125 grams **F** \$5.10; 250 grams **G** \$6.95; 500 grams **H** \$12.25



1606 Snap Pea Sugar Lace (65 Days)
Semi-leafless variety. No need for staking as plants are upright and strong (30 cm/1 ft tall), making this easy to harvest. The stringless pods are 8 cm (3 in) long.

FEATURE SPECIALTY PEAS



1610 Spring (57 Days)
An excellent table quality, fast growing, early variety for the garden. Pods are medium-sized 8 cm (3 in) and are a rich, uniform dark green.



1675 Snow Pea Purple (52 Days)
Dwarf-sized plants with delicate purple flowers. The compact yet productive plants are beautiful in any garden space, from containers to standard rows. Early maturing, bright green, shiny, pods are flat and crunchy. In ground plants will reach 60 cm (24 in).
Please note Pkt. A is 25 grams.
Pkt. 25 Grams **A** \$4.70; 125 Grams **F** \$9.75; 250 Grams **G** \$16.75; 500 Grams **H** \$27.95

Approximately 30-40 pea seeds per 10 gram
50 gram Pea pkt. sows about 6 M (20 ft) row

FOR BEST CROPS: Mix Peas with this



Not just for peas or beans, but all seeds you grow! Dust inoculant (rhizobial bacteria) onto beans or peas before planting to draw more nitrogen for plants.
3276 Seed Dressing (Inoculant)*
Sufficient material to pre-inoculate up to 3.6 kilos (8 lb) of seed prior to planting.

42 grams (1.5 oz.) **A** \$11.95; 2 or more \$10.95

*Manitoba customers: these items are taxable

DILL



842 Dill
Most often used at flowering stage but can also be used in young green stage before flowers form. Famous flavour for dill pickles. Also adds flavour to soups and zest to sauces or boiled potatoes.

Pkt. **A** \$4.35; 25 grams **E** \$7.15;
125 grams **F** \$15.40;
500 grams **H** \$32.35

840 Fernleaf
Fernleaf is a basal branching, compact, bushy plant around 40 cm (16 in) that is ideal for small gardens. Slow to bolt. Succession plant this dill to ensure a constant supply through the whole season! Also an important food for the Swallowtail butterflies.

250 seeds **A** \$4.80; 2,500 seeds **C** \$17.75

GARDENING MADE SIMPLE SQUARE FOOT GARDENING!



3300 Seeding Square – Gardening made simple!

This square foot template helps you maximize growth in limited space. The concept is based on a popular method, whereby seeds are sown in specific positions within one square foot, allowing enough room for each to grow to maturity without wasting space. Simple to use, the template shows correct seed spacing with colour-coded holes matched to a planting chart of 46 vegetables, allowing you to quickly know where to drop seed. A graduated dibbler takes the guesswork out of setting the right planting depth. The dibbler also functions as a seed spoon, which can be used with the included funnel to deposit tiny seeds accurately. When you're done seeding one section the template can be moved over to plant the adjacent square foot, letting you use it to plant your entire garden. Made from durable ABS and polypropylene plastic. Each **A** \$41.95; 2 or more \$39.95 each

STEVIA

WATER CRESS

RUTABAGA

TURNIP



839 Stevia (Fragrant)
An outstanding herbal sugar substitute, non-caloric alternative to artificially produced sugar substitutes. The sweet compounds pass through the digestive process without chemically breaking down, making stevia safe for those who need to control their blood sugar level. Ht 40-45 cm (16-18 in).

15 seeds **A** \$4.80;
75 seeds **B** \$18.95

867 Watercress (60 Days)
When it comes to a salad leaf that is truly good for you, look no further than watercress. Bursting with vitamins and minerals, this peppery little leaf is one of the natural super foods and it tastes great too! Use it on sandwiches, toss into salads, use it to make watercress soup or sauce, wilt into pastas or stir fries - it's incredibly versatile!

Pkt. **A** \$4.25; 5 grams **B** \$8.25 Multi-Seed Pellets.
Pkt. 10 pellets **C** \$3.95; 50 pellets **D** \$13.95; 100 pellets **E** \$24.95

2520 Laurentian (90 Days)
If you prefer a late fall rutabaga with yellow flesh, grow this variety. A good rutabaga grown extensively by market gardeners.

Pkt. 7 grams **A** \$5.15; 25 grams **E** \$10.25; 125 grams **F** \$34.95;
500 grams **H** \$80.00

2505 Hybrid Royal Crown (55 Days)
Huge, uniformly round, purple-top turnip has mild flavour and no coarse fiber. Use the tasty leaf green tops, too. They make a tangy boiling green.

Pkt. 5 grams **A** \$5.45; 25 grams **E** \$26.75; 125 grams **F** \$80.00

SEED STARTING FERTILIZER



3287 Evolve Seedling Starter*
An organic fertilizer that promotes quick germination, massive root development and quick emergence. Seedling Starter organic fertilizer is derived from digested vegetable meal, bat guano, citric acid and kelp meal. If you liked using No-Damp, you will love using EVOLVE Seedling Starter organic fertilizer. A little goes a long way! Mix at rate of 3 ml of seedling starter to 1 L of water.

500 ml **A** \$16.50; 2 or more \$15.50

Jump Start your Garden!



1382 Hakurei Salad Turnip (38 Days)
Round, smooth, white roots that mature early, just after radishes, and are best harvested young. Eaten raw, the flavour is sweet and fruity, and the texture is crisp and tender, also excellent roasted! The dark-green tops are useful raw or lightly cooked with the roots.

100 seeds **A** \$4.35; 500 seeds **B** \$15.00; 1,000 seeds **C** \$27.00



Amazing Flavour!



PEPPERS



1770 Orange King (72 Days)
A bright orange bell pepper that will yield nice quantities of thick-skinned large sweet peppers. Colourful and delicious, they'll add colour to your salads and are perfect for stuffing!
Prices below.

FEATURE PEPPER



1085 Early Prolific Hybrid (55 Days)
Produces far earlier than any other sweet pepper on the market. The fruit is 3-lobed, with medium thick walls and a mild sweet flavour. A long time customer favourite!
Pkt. 25 seeds **A** \$6.95; 150 seeds **B** \$41.25; 500 seeds **C** \$89.95; 1,000 seeds **D** \$161.90



Unique Bell

1733 Chocolate Bell (75 Days)
If you are looking for a new twist on a summer vegetable garden classic, the unique flesh is cola-red colour, very sweet and delicious. Beautiful addition on salads and other meals. The medium-sized semi-bell shaped fruit ripen very early, making this variety perfect for the North or anyone who loves early peppers!
Pkt. 25 seeds **A** \$5.45; 150 seeds **B** \$20.95; 500 seeds **C** \$54.95; 1,000 seeds **D** \$98.90



1735 Sunbright Hyb. (75 Days)
A beautiful canary yellow bell pepper. Perfect for stuffing or adding a splash of colour to your salads. Will yield nice quantities of large sweet peppers that turn from green to bright yellow when mature.
Prices below.



1710 Fat N' Sassy Hyb. (65 Days)
No other sweet bell pepper matches this one for big fruit size! Reaches maturity early, turning from green to red far before any other pepper of its kind! Thick walled pepper, perfect for stuffing or sautéing.
25 seeds **A** \$4.95; 150 seeds **B** \$24.50; 500 seeds **C** \$58.95; 1,000 seeds **D** \$106.10



1720 Northstar Hybrid (68 Days)
This productive, fast growing, early pepper produces large 4-lobed crisp fruit all summer. One of our most popular peppers!
Pkt. 25 seeds **A** \$6.95; 150 seeds **B** \$41.25; 500 seeds **C** \$89.50; 1,000 seeds **D** \$161.10



1715 Aruba Stuffing Hybrid (65 Days)
Bountiful harvests of mild 15 cm (6 in) long lime green peppers early in the season. Great for roasting, grilling, pickling and stuffed peppers. Continuous setting through the whole season. Plant height is 55-65 cm (22-25 in) tall. Adaptable to patio containers.
Pkt. 25 seeds **A** \$5.95; 150 seeds **B** \$24.50; 500 seeds **C** \$58.95; 1,000 seeds **E** \$106.10



1730 Purple Beauty (70 Days)
Compact plants yield thick walled dark purple peppers. The colour goes from green to purple to deep red. Crisp texture and mild, sweet flavour will make this one popular with everyone!
Prices for above 3 Peppers:
Pkt. 25 seeds **A** \$6.95; 150 seeds **B** \$49.95; 500 seeds **C** \$175.00; 1,000 seeds **D** \$315.00



1762 Majestic Red Hybrid (78 Days)
Large, blocky peppers have a mild, sweet flavour, weigh 4 to 6 ounces each and are smooth with thick, crunchy walls. Fruits are heavy for their size and perfect for stuffing! They mature from green to bright candy-apple red.
Prices for above 2 Peppers:
Pkt. 25 seeds **A** \$6.45; 100 seeds **B** \$20.25; 200 seeds **C** \$39.50



1761 California Golden Wonder (75 Days)
A golden version of the red California Wonder. bears heavy, smooth-skinned, thick-walled, blocky peppers on vigorous 45-60cm (18-24") tall plants. Peppers are 4-lobed and start out light green and mature to a golden-yellow.



1751 Sweet Sunset Hybrid (80 Days)
A colourful sweet banana pepper with a compact, upright habit that is perfect for container planting! Great for fresh and canning uses as well as for salads, roasted, fried or pickled.
Pkt. 25 seeds **A** \$5.45; 150 seeds **B** \$36.75; 500 seeds **C** \$96.75

HOT PEPPERS



Ghost Hot - Yikes!

1798 Ghost Hybrid (90 Days)

855,000 Scoville heat units. One of the hottest peppers in the world. Plants start out slow but eventually grows tall, exceeding .6 m (2 ft). The thin-walled, wrinkled, pointed fruits reach 5 to 7 cm (2 to 3 in) in length, ripening mostly to red.

Pkt. 10 seeds **A** \$5.95; 25 seeds **B** \$13.25; 50 seeds **C** \$23.85

**1755 Mike Stefancsik's Hungarian**

A family heirloom from Mike Stefancsik, Lethbridge, AB, who describes this as a medium sized, green chili type pepper with "extreme" heat, which mature to a beautiful orange colour. 4,000 - 6,000 Scoville heat units.

Pkt. 25 seeds **A** \$4.95; 150 seeds **B** \$17.95; 500 seeds **C** \$40.00



Perfect In Containers

1745 Cajun Belle Hybrid (60 Days)

500-4,000 Scoville heat units. Just the right combination of heat and sweetness. The fruit look like small bell peppers and when left on the plant, fruit will change colour from green to scarlet and ripen to deep red. Compact 60 cm (2 ft) tall plants.

Pkt. 15 seeds **A** \$5.95; 50 seeds **B** \$18.95; 100 seeds **C** \$35.90

**1792 Primero Red Habanero Hybrid (75-80 Days)**

100,000+ Scoville units. Expect huge yields of peppers that are larger than other habaneros. Big, bright red 5-9 cm (2-3.5 in) with about one third of the heat of traditional rich habaneros without the extreme burn!

Pkt. 15 seeds **A** \$5.45; 50 seeds **B** \$19.95; 100 seeds **C** \$35.90

**1742 Sriracha (red jalapeño) (80 Days)**

2,300-2,500 Scoville units. If you like sriracha sauce this is the pepper for you! Large dark green fruits turn to red with smooth skin and good shelf life. For growing in patio containers, be sure to choose a sunny location with 6+ hours of sun. Ht: 50 cm (19 in).

Pkt. 25 seeds **A** \$6.95; 150 seeds **B** \$24.95; 300 seeds **C** \$44.90

**1775 Mucho Nacho Jalapeño Hybrid (68 Days)**

4,500-6,000 Scoville units. A jumbo sized jalapeño type that will produce 10 cm (4 in) long fruit in abundance. Best of all the fruit is fatter, heavier, thicker and somewhat hotter than regular jalapeños.

Pkt. 25 seeds **A** \$5.45; 150 seeds **B** \$19.95; 500 seeds **C** \$49.50; 1,000 seeds **D** \$89.50

**1740 Big Chili Hybrid (68 Days)**

An excellent large 20 cm (8 in) long pepper with thick flesh and low pungency (about a third of jalapeños). Fruit mature green to red, but are used mostly as green. A very heavy producer.

Pkt. 25 seeds **A** \$4.95; 150 seeds **B** \$18.95; 500 seeds **C** \$45.95; 1,000 seeds **D** \$82.70

**1752 Hot Sunset Hybrid (85 Days)**

650 Scoville heat units. Thick-walled peppers, have a great flavour with less spice. Vigorous plants produce fruits, up to 17 cm (7 in) all season long. Try them fresh, pickled, or roasted.

Pkt. 25 seeds **A** \$5.95; 150 seeds **B** \$36.75; 500 seeds **C** \$96.75; 1,000 seeds **D** \$174.15

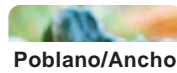

Poblano/Ancho



1780 Baron Ancho

1780 Baron Ancho Hyb. (70 Days)

1,000-2000 Scoville heat units. Large fruits averaging 12 cm (5 in) long. Referred to as poblano when green & ancho when dried. Price below.

1725 Arapaho Hyb. (70 Days)
2,000-4,000 Scoville units. Productive and spicy. Medium-thick walls with a high yield potential. The peppers dry well for making homemade hot chili powder.

prices for 1725 & 1780

Pkt. 15 seeds **A** \$5.50; 100 seeds **B** \$26.80; 500 seeds **C** \$96.75



Cayenne



1725 Arapaho

**1795 Helios Hybrid (87 Days)**

Habanero hybrid; 75,000 Scoville heat units. High yields of 6 cm (2.5") long by 4 cm (1.5") wide habanero hot peppers. Peppers turn from green to dark orange when mature.

Pkt. 25 seeds **A** \$5.95; 150 seeds **B** \$24.50; 500 seeds **C** \$74.95; 1,000 seeds **D** \$134.90



Spicier!

**1785 Serrano Del Sol Hybrid (65 Days)**

10,000-23,000 Scoville units. Serrano peppers are traditionally used green, can be served in the same way as jalapeños (think nachos, salsa, or chili). The cylindrical fruit are dark green, thick-walled and 10 cm (4 in) long. Tall plants, 60 cm (24 in) and very prolific!

Pkt. 25 seeds **A** \$5.45; 150 seeds **B** \$17.95; 500 seeds **C** \$49.50; 1,000 seeds **D** \$89.10

**1772 Jalapeño M (70 Days)**

2,000 to 5,000 Scoville units. Pungent, thick-walled and juicy dark green peppers that are 8 cm (3in) long and about 2 cm (1in) wide with a blunt end. Great fresh and used for "poppers". Use green peppers for fresh eating, pickling, and sauces, and dry the red ones. Dried, smoked jalapeños are known as chipotle.

Pkt. 25 seeds **A** \$5.45; 150 seeds **B** \$13.75; 300 seeds **C** \$23.95; 1,000 seeds **D** \$89.50

**1797 Tabasco (80 Days)**

30,000-50,000 Scoville heat units. This fiery hot pepper made tabasco sauce famous. The small, light yellow-green peppers turn to red, growing on tall plants. Tabasco peppers are used fresh, or dried and ground into a powder. Easy to grow and great for small gardens and patio pots.

Pkt. 25 seeds **A** \$4.95; 150 seeds **B** \$14.95; 500 seeds **C** \$41.55

RADISHES

PUMPKINS



1890 Champion (23 Days)
These bright, cherry red radishes are large, smooth and round with a mild, crisp, sweet flavour. Prices below.



1930 Cherry Belle (24 Days)
You asked for it and we brought it back! This very early, solid and crisp cherry red radish has been a favourite of gardeners for years. Prices below.



1900 French Breakfast (25 Days)
Medium length, scarlet roots with a white tip. Should be harvested young for a crisp and mild flavour. Prices below.



1950 Easter Egg Mixture
Try this blend of radishes all contained in one packet. A colourful mixture of white, red, pink, purple and violet. All crisp and sweet with pure white flesh
Prices for all above varieties
Pkt. 7 grams **A** \$4.25; 25 grams **E** \$8.25; 125 grams **F** \$13.50; 500 grams **H** \$25.70

Approximately 100 radish seeds per gram

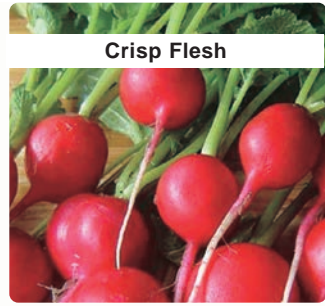

1980 Rover Hybrid (21 Days)
Most radishes get bitter and brittle from the hot summer, but Rover keeps its cool! Rover is extra early and has less of a tendency to produce oval radishes under heat stress than other varieties. The smooth, dark-red roots are extremely uniform and attractive with crisp, white flesh. Rich flavour with a refreshing nip!
Pkt. 200 seeds **A** \$4.80; 1,000 seeds **E** \$8.35; 5,000 seeds **F** \$19.95



1891 Watermelon (60 Days)
When sliced this radish looks just like a watermelon with a green rind and rosy interior. Just gorgeous in a salad raw, this radish can also be roasted, added to stir fries, sautéed, added to stews, or even boiled and mashed! Milder than most radishes. Later type!
Pkt. 7 grams **A** \$4.80; 25 grams **E** \$10.50; 125 grams **F** \$18.75



1810 Lumina Hybrid (90 Days)
A spooky addition to your Halloween celebrations! Fruits, 4.5 kg (10 lb) and have delicious orange flesh that stores well.
Pkt. 15 seeds **A** \$4.65; 100 seeds **D** \$24.50; 250 seeds **E** \$47.95



1804 Naked Bear Hyb (105 Days)
The thick flesh is creamy and sweet for pies and other fall recipes. The pumpkin seeds are born bare-naked Hulless, for snacking and baking. Perfect for fall decorating and Jack O'Lanterns. Produces .9-1.8 kg (2-4 lb) dark orange fruit.
Pkt. 10 seeds **A** \$4.65; 50 seeds **B** \$17.95; 100 seeds **C** \$32.30; 250 seeds **D** \$55.95



1835 Gumdrops Hybrid (100 Days)
Gumdrop gets your attention with rich orange colour, a unique flat bottom, and a big, sturdy handle. The avg. 11-13 lb. pumpkins are an ideal size for kids, or for accenting any fall display.
Pkt. 10 seeds **A** \$4.65; 50 seeds **B** \$19.95; 100 seeds **C** \$35.90; 250 seeds **D** \$58.25



1860 Howden (115 Days)
One of the best pumpkins for Halloween carving! Big 10 kg (25 lb) fruits bright orange with defined ribbing and solid handles make this pumpkin ideal for carving as well as pies or roasted seeds.
Pkt. 25 seeds **A** \$4.95; 100 seeds **D** \$15.50; 250 seeds **E** \$22.00; 500 seeds **F** \$39.60



1840 Jack of all Trades Hybrid (100 Days)
Each 4.5-6.8 kg (10-15 lb), bright orange coloured fruit has a flat base and a deep, rounded shape. After carving this pumpkin, don't waste the sweet, orange flesh as it makes delicious pumpkin pies and soup!
Pkt. 25 seeds **A** \$5.95; 100 seeds **D** \$22.30; 250 seeds **E** \$39.00; 500 seeds **F** \$70.20



1887 Big Max (110 Days)
Handsome pumpkins, up to 100 lbs. or more, make excellent pies and impressive Jack O'Lanterns. Fine-grained, bright orange flesh is great for canning or freezing.
Pkt. 10 seeds **A** \$4.95; 25 seeds **B** \$12.25; 100 seeds **C** \$36.75

FEATURE PUMPKIN

1820 Neon Hybrid (80 Days)
Ripening extra early to accelerate the pumpkin harvest, you can start picking up to a month earlier than many other pumpkins. Just right for pies and Jack O'Lanterns, the 3-4 kg (7-8 lb), uniform globes measure about 25 cm (10 in.) wide and 22 cm (8.5 in.) tall. Semi-bush plants.
Pkt. 25 seeds **A** \$5.75; 100 seeds **D** \$24.50; 250 seeds **E** \$42.95; 500 seeds **F** \$77.30

SQUASH



2115 Acorn Table King (85 Days)
Early maturing, bushy plants that have excellent eating and keeping qualities. Fruit average 500 grams (1 lb). Flesh is a deep yellow colour and sweet.

Pkt. 25 seeds **A** \$4.55; 25 grams
E \$10.50; 125 grams **F** \$19.95



2120 Frisco Butternut Squash Hybrid (90 Days)
Newer variety with a thicker, longer neck than other butternuts, making it exceptionally easy to peel for Italian risottos and soups. Bright orange flesh is sweet. Large 2.2-2.7 kg (5-6 lb) fruits on productive vines. Excellent winter storage variety.

Pkt. 15 seeds **A** \$5.80; 100 seeds
B \$19.95; 250 seeds **C** \$42.35



2160 Winter Sunshine Hybrid (80 Days)
Makes the best soup! Vibrant orange-red skin is very distinctive! Flesh is also a deep orange with a sweet, nutty, creamy smooth flavour. Stringless. Fruit is 1.5 - 2 kg (3-4 lbs).

Pkt. 10 seeds **A** \$5.80; 100 Seeds
B \$29.00; 250 seeds **C** \$53.50



2165 Honey Bear Hybrid (100 Days)

Honey Bear acorn squash was bred to be baked and served in the half shell. This squash has three outstanding qualities: its compact plant, high yield, and tolerance to powdery mildew. The bushy plant will reach 1 m (3 ft) tall and spread 1.5 m (5 ft) without vines. The dark green acorn squash weighs about a pound, which is a perfect size for sharing between two people!

Pkt. 15 seeds **A** \$5.80; 100 seeds
B \$19.95; 250 seeds **C** \$32.95



2180 Tivoli Spaghetti Squash Hybrid (100 Days)
The first bush spaghetti squash. Like other bush winter squash, it will produce short vines after the initial fruit set. Tivoli has a creamy flesh and small plant habit that offers high yielding potential. Perfect for squash lovers with smaller spaces.

Pkt. 15 seeds **A** \$5.95; 100 seeds
B \$19.95; 250 seeds **C** \$42.35

FEATURE SQUASH



2118 Squash Honeynut (100 Days)

New open pollinated! Mini butternut squash on a compact bush plant. The 12 cm (5 in) long fruit weigh from 400 to 700 grams (1-1.5 lbs) and have a very sweet and rich flavoured deep orange flesh. Exceptional yields of individual-size butternut Squash, simply cut in half and bake! Stores well.

Pkt. 15 seeds **A** \$4.55; 100 seeds
B \$10.60; 250 seeds **C** \$19.95



2152 Baked Potato Hybrid (105 Days)

A whole new look to acorn squash. Bush-type plants with fruits that start off white and mature to a tan colour. Expect an abundance of 450 to 700 gm (1 to 1½ lb) fruits with a sweet, nutty flavour that oddly looks like baked potatoes. Perfect for fall soup, roasting and pie. Prices below with 2150



2155 Sweet Mama Hybrid (75 Days)
A kabocha-type squash with dark green, drum-shaped, .9-1.3 kg (2-3 lb) fruits. Thick flesh has very smooth texture and mild, sweet flavour. Fruits store up to 4 months. High-yielding compact vines are perfect for small gardens.

Pkt. 15 seeds **A** \$5.95; 100 seeds
B \$25.75; 250 seeds **C** \$53.50



2111 Winter Squash Burgess Buttercup (100 Days)

The best flavoured winter squash available. Thick, orange flesh cooks dry, tastes like sweet potatoes! Deep green skin is flecked with gray. Squash weigh in at 2 kg (4.5 lbs). Good baker--but stores well too!

Pkt. 25 seeds **A** \$4.55; 25 grams
E \$10.50; 125 grams **F** \$19.95



2110 Scallop Squash Sunburst Hybrid (50 Days)

A summer squash with bright yellow colour with a dark green sunburst pattern on both blossom and stem ends. The bush-type plants are loaded with vividly coloured fruit. Extremely tasty when harvested young 2 to 6 cm (1-3 in). Interior flesh is creamy white and tender with a mild, buttery flavour.

Pkt. 15 seeds **A** \$5.80 100 seeds
B \$19.95; 250 seeds **C** \$39.95



2150 Mashed Potato Hybrid (90 Days)

This squash has white flesh which takes on the appearance of mashed potatoes when cooked and fluffed. A good, low carbohydrate alternative to mashed potatoes. Each fruit averages about 750 gm (1½ lbs) and sets close to the crown of the plant.

10 seeds **A** \$5.80; 50 seeds
B \$19.95; 100 seeds **C** \$35.95;
250 seeds **D** \$69.95

Approximately 10
squash seeds per gram

ZUCCHINI



2105 Golden Glory Hybrid (50 Days)
This open plant habit makes it easy to harvest, 20 cm (8 in), high-quality fruit. Continuously sets tasty zuke's! A beauty in the garden!
Prices below.



2108 San Isidro Hybrid (45 Days)
Speckled grey-green Mexican zucchini that is popular in gourmet dishes. Nearly spineless plant is highly productive. 17 cm (7 in) long.
Prices below.



2103 Midnight (Noche) Hybrid (42 Days)
A high yielding, nearly spineless dark green fruit. Open plant habit makes for an easy harvest of the high quality fruit! Uniform 20 cm long by 5 cm (2 in) round cylindrical fruit. **Prices below.**



2100 Spineless Perfection Hybrid (44 Days)
A new spineless zucchini with attractive high gloss, 20 cm (8 in) straight fruit. An easy pick plant with open habit, enhanced disease resistance and nice looking cylindrical fruit with minimal scarring. This is an excellent mid to late season variety.

Prices for all above Zucchini;
Pkt. 15 seeds **A** \$5.95; 100 seeds **B** \$24.50; 250 seeds **C** \$52.00



2109 Eight Ball Hyb. (50 Days)
Harvest these perfectly round globes anytime from golf ball to cue ball size. The shiny speckled green fruit with creamy white flesh also make perfect single-serving bowls when sliced in half and scooped out.

TOMATOES

Easy to grow. Start seed in a warm place in mid-March, plant under Kozy-Coats at the end of April. If you're not using frost protectors, start seed in mid-April.



"ALL-CANADIAN"

FEATURE TOMATOES



2355 Charlie's Red



2280 Prairie Pride



2312 Manitoba

BRED TO BE EARLY
THE MANITOBA COLLECTION

Outstanding varieties that have passed the test by thousands of gardeners! The University of Manitoba's George Luther is responsible for Prairie Pride, Dr Charlie Walkof developed Charlie's Red Staker & Manitoba Tomato at the Morden Research Station in Manitoba. Manitoba Proud!



2280 Prairie Pride (55 Days) – Bush type

Abundant, flavourful, low acid content, medium-sized fruit on sturdy, compact plants. Determinate type.



2312 Manitoba (60 Days) – Bush type

Has pleased customers for years! This bush will produce many fine, firm 175 gm (6 1/2 oz) brick-red medium Tomatoes. Popular everywhere! Determinate type.



2355 Charlie's Red Staker (65 Days) – Staking type

Larger smooth-skinned, very uniform and prolific producer. Staking type.

The above three are also available in collection below.

Please use the number beside each name when ordering individual packages.
Pkt.50 seeds **A** \$4.55; 500 seeds **B** \$13.25; 1,000 seeds **C** \$23.85

M150 Manitoba Collection A \$5.95

Collection – 1 packet each of the above three, 15 seeds per packet.



2318 Evan's Extra Early (57 Days)

Well flavoured firm, red mid-sized tomatoes are carried in large clusters. In Alberta garden trials it regularly ripens some 10 to 15 days earlier than other known cultivars. A good yielding garden tomato that gives you a head start on the competition. Developed from Dr. Ieuan Evans from Devon, Ab. Determinate.

Pkt. 50 seeds **A** \$4.55; 250 seeds **B** \$9.95; 500 seeds **C** \$17.90



WE HAVE MORE
ON OUR WEBSITE
TTSEEDS.COM

- ✓ MORE Variety
- ✓ MORE Accessories
- ✓ MORE Information

CHECK
OUR WEBSITE
FOR OUR
PICKLING RECIPE
USING ZUCCHINI!

TOMATOES

Easy to grow. Start seed in a warm place in mid-March, plant under Kozy Coats at the end of April. If you're not using frost protectors, start seed in mid-April.



TOP-NOTCH FLAVOUR



2328 Tomato - Mountain Fresh Hybrid (72 Days)

Produces good yields of 225 - 335 gram (8 to 12 oz) tomatoes. Sweet, firm, smooth, and most of all flavourful. Perfect for salads, slicing, and sandwiches. Crack resistant. Does well in cool or wet climates. It is the most widely grown market tomato and is an excellent choice for home gardens or market growers. Staking type.

Pkt. 15 seeds **A** \$4.80; 50 seeds **B** \$17.50; 100 seeds **C** \$31.50; 250 seeds **D** \$62.50

DID YOU KNOW ?

Determinate - ripen early, great for canning and storing

Indeterminate - have a longer growth period and will produce until frost arrives, making these great for snacking fresh off the vine



2308 Bush Beefsteak (62 Days)

Produces lots of 250 gm (8 oz) rich red solid fruit on a compact bushy plant. A nice slicer for hamburgers and tomato sandwiches. Very popular early-season variety. Vigorous growth. Determinate type.

Pkt. 50 seeds **A** \$4.55; 500 seeds **B** \$11.95; 1,000 seeds **C** \$21.50; 2,000 seeds **E** \$36.75



2315 Centennial Rocket (50 Days) – Bush type

Only half the leaves of other tomatoes, so most of the energy goes into early medium-size fruit. Introduced in Lacombe AB in 1967. Determinate type.

Pkt. 50 seeds **A** \$4.55; 500 seeds **B** \$11.95; 1,000 seeds **C** \$19.95; 2,000 seeds **E** \$36.75



2394 Brandywine

Proven old timer! Prized for its incredible flavour. These unique plants—very distinct leaf shape—will produce 600g (1.5 lb) fruit easily. Tempting pink-red colour with a creamy aftertaste! Staking type.

Pkt. 25 seeds **A** \$5.00; 100 seeds **B** \$15.75

GIANT Tomatoes – for fun & taste!



2390 T&T Monster (100 Days)

Proven winner over the years! Will always give you delicious large tomatoes. Easily reach 900 gm (2 lbs)—ideal for competitions. Holds world record of over 2.5 gm (6 lbs). Staking type.

2392 Delicious (77 Days)

Delicious is an indeterminate heirloom slicing tomato with excellent flavour (hence the name). Crack resistant fruits average 1-2 lbs, but can be much larger. This variety of tomato previously held the world record for the largest tomato at over 7 lbs.

Prices for The Giants;
Pkt. 25 seeds **A** \$5.00; 100 seeds **B** \$15.75; 200 seeds **C** \$28.35



2395 Giant Collection
All 3 packets **A** \$13.95

Approximately 400 tomato seeds per gram

2393 Pruden's Purple (72 Days)

A flavour that rivals the famous Brandywine but ripens 2 weeks earlier. Deep pink, almost purple, ribbed fruits can weigh over 1 lb and are resistant to cold and cracking. Excellent for cooking, salsas, sandwiches and salads. Indeterminate plants. Staking type.



EARLY RIPENING



2327 Primo Red Hybrid (64 Days) (Bush Type)

This very early, extra large vine ripe tomato will surprise you with its size and flavour! The tomatoes are a smooth globe shape and reach 225 to 340 gms (8 to 12 ozs) easily. Excellent compact growth habit that will provide you with loads of uniform tasty tomatoes! One of this year's gems! Large determinate type.

Pkt. 25 seeds **A** \$8.75; 250 seeds **B** \$69.25; 500 seeds **C** \$124.65

TOMATOES

Improved Sweet Cluster!



2345 Big Beef Hybrid (70 Days)
Real old-time flavour, good fruit size (350 gm/12 oz), disease resistant and a very heavy yield. Great improvement over the beefsteak variety. Indeterminate.

Pkt. 25 seeds **A** \$5.50; 250 seeds **B** \$39.95; 500 seeds **C** \$71.90; 1,000 seeds **D** \$105.25



2340 New Girl Hybrid (62 Days)
An improved First Lady! Outstanding flavour and disease resistance. The fruits weigh 4-7 oz. and hold their ripeness and flavour on the vine very well. Indeterminate.

Pkt. 25 seeds **A** \$3.95; 250 seeds **B** \$31.30; 500 seeds **C** \$56.35; 1,000 seeds **D** \$79.95



2320 Early Girl Hybrid (55 Days)

One of the earliest regular sized tomatoes available. It produces juicy, tangy 170 gram (6 oz) tomatoes right through the whole summer! Highly rated by many of our customers. Indeterminate.

Pkt. 15 seeds **A** \$4.80; 250 seeds **B** \$33.50; 500 seeds **C** \$60.30; 1,000 seeds **D** \$96.75

2335 Carmello Hybrid (70 Days)
Improved Sweet Cluster! Heavy clusters of round fruit on strong, uniform plants. Especially impressive is its generous size fruit and well-developed flavour for such an early tomato. Indeterminate.

Pkt. 25 seeds **A** \$4.80; 250 seeds **B** \$31.25; 500 seeds **C** \$50.00; 1,000 seeds **D** \$79.95

Popular Request!

2349 Super Fantastic Hybrid (70 Days)

Early maturing plant produces high yields of 280 gr (10 oz) red beefsteak tomatoes. They are juicy, meaty, and very flavourful. Perfect for salads, slicing, sandwiches, salsas, drying, and canning. Indeterminate.

Pkt. 15 seeds **A** \$4.75; 50 seeds **B** \$15.75; 100 seeds **C** \$28.35; 250 seeds **D** \$55.75



Great For Containers



2306 Better Bush Hybrid (68 Days)

Very compact plant that is excellent in containers and small gardens. Tasty, medium-sized tomatoes great for sandwiches and slicing.

Pkt. 25 seeds **A** \$4.55; 250 seeds **B** \$19.00; 500 seeds **C** \$34.20; 1,000 seeds **D** \$53.95



2310 Bush Early Girl Hybrid (54 Days)

The "little sister" to early girl because the plant is so compact but fruit is bigger than early girl. Produces an abundance of tomatoes. Outstanding juicy flavour! Fruit size 200 – 300 gr (7 – 12 oz).

Pkt. 15 seeds **A** \$4.80; 250 seeds **B** \$33.50; 500 seeds **C** \$60.30; 1,000 seeds **D** \$96.75



2379 Black Krim (80 Days)

Dark brown-red colour that gets even darker in hotter weather. Always a favourite in taste test! The flavour is described as tangy, rich, and sweet. It makes beautiful dark slices, perfect for sandwiches and salads! High yielding. Indeterminate.

Pkt. 25 seeds **A** \$4.55; 250 seeds **B** \$15.75; 500 seeds **C** \$28.35



2360 Better Boy Hybrid (70 Days)

Produces an abundance of smooth-skinned, 450 gram (1 lb) tomatoes. "The most popular tomato in North America," according to the book "The Total Tomato". Indeterminate.

Pkt. 25 seeds **A** \$5.80; 250 seeds **B** \$31.95; 500 seeds **C** \$57.50; 1,000 seeds **D** \$91.95



2300 Celebrity Tomato Hybrid (66 Days)

Heavy yields of tasty tomatoes that can be used fresh or in cooking, canning, juicing, salsa, or for slicing. Although classified as a determinate, Celebrity often continues to produce tomatoes until frost that weigh approximately 8 oz., and are 4 inches across.

25 seeds **A** \$5.50; 250 seeds **B** \$27.95; 500 seeds **C** \$50.30



Low In Acid

2290 Lemon Boy Hyb (72 Days)

The largest, exceptionally early yellow tomato you'll ever grow! Interesting low-acid taste. Bush type.

Pkt. 25 seeds **A** \$4.80; 250 seeds **B** \$38.95; 500 seeds **C** \$70.10

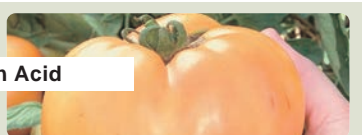

2292 Carolina Gold Hyb (71 Days)

Meaty with a sweet, mild flavour, these extra-large, smooth fruit will bring a sunny glow to your salads and dishes. Bush type.

Pkt. 15 seeds **A** \$4.80; 50 seeds **B** \$11.95; 100 seeds **C** \$21.50; 250 seeds **D** \$45.75

GREENHOUSE



2380 Cobra Hybrid (70 Days)

Cobra has gained strong recognition both in greenhouse and open field production. High yields of uniform glossy fruit. Large, round to oblong, 225 gm (8 oz) fruit are firm, extremely resistant to cracking with excellent external quality.

Pkt. 10 seeds **A** \$11.25; 25 seeds **B** \$25.75; 50 seeds **C** \$46.35

CHERRY TOMATOES

Ideal For Containers

**2363 Tumbler Hybrid (60 Days)**

This very outstanding cherry tomato will produce loads of 5 cm (2 in) fruit. Tasty, juicy and a very attractive plant! Bush hanging type.

Pkt. 15 seeds **A** \$6.70; 50 seeds **B** \$15.75; 250 seeds **C** \$59.00

So Sweet!

**2368 Sunsgar Hyb. (60 Days)**

Absolutely the sweetest tasting cherry tomato! Unique golden colour will stand out in any salad, both in flavour and look. Customer favourite for years! Staking type

Pkt. 25 seeds **A** \$6.55; 250 seeds **B** \$46.95; 500 seeds **C** \$84.50

Grape Types

**2361 Sugary Hybrid (60 Days)**

Outstanding sweet, juicy flavour! This vigorous vine (semi-determinate) will produce loads of oval-shaped cherry tomatoes in 'grape-like' clusters. Fruit is a reddish-pink colour and will produce all season long. Staking type.

Pkt. 15 seeds **A** \$4.80; 50 seeds **B** \$13.25; 100 seeds **C** \$24.05

**2356 Ruby Crush Hyb. (65-70 Days)**

The first ever grape determinate type! It works in a container, it shines in the field, and the sugary-acid balanced fruits resist cracking. Compact plants can be grown with minimal support (60 cm / 2 ft high fence trellising or standard tomato cage). Fruit are solid, oval, and weigh about 15 grams (1/2 oz) each. Determinate.

Pkt. 10 seeds **A** \$6.85; 25 seeds **B** \$17.50; 50 seeds **C** \$31.50

**2381 Chocolate Sprinkles Hybrid (60 Days)**

Bite-sized, cherry-type fruits are beautifully coloured. Red striped with dark green, they explode with rich, robust flavour. This highly productive plant forms its fruit in clusters, and starts bearing early in the season. Staking type.

Pkt. 10 seeds **A** \$5.25; 50 seeds **B** \$21.25; 100 seeds **C** \$38.25

**2371 Super Sweet 100 Hybrid (65 Days)**

Scarlet, cherry-sized tomatoes bursting with sugary flavour produce long clusters right up to frost. Indeterminate. Staking type.

Pkt. 25 seeds **A** \$5.25; 250 seeds **B** \$29.00; 500 seeds **C** \$52.20



Ideal for baskets and containers from which it will gently tumble. Produces lots of sweet, medium sized cherry fruits. Cascades of bright red or yellow cherry tomatoes right on your deck. Ideal for hanging baskets. Produces loads of very nice 15-20 gm (3/4 oz) tomatoes with very rich flavour.

2358 Container Cherry Hybrid Tomato Tumbling Red (65 Days)**2359 Container Cherry Hybrid Tomato Tumbling Yellow (65 Days)**

Pkt. 15 seeds **A** \$4.55; 50 seeds **B** \$13.35; 250 seeds **C** \$39.00

Beefsteak In Containers

**2307 Big League Hyb. (68 Days)**

If you want large tomatoes but have limited space, this is the perfect pick! A true container-type tomato producing the largest tomatoes in the shortest time early maturing, beefsteak fruit are excellent for fresh eating and salads. Due to the sheer weight of the 400 – 600 gms (14-21 oz) fruit, support will be required. Determinate.

Pkt. 15 seeds **A** \$4.55; 50 seeds **B** \$11.25; 100 seeds **C** \$20.25

**2374 Sugar Rush**

An indeterminate, regular leaf, tomato plant that grows between 0.9-2.7 m (3-9') tall under ideal conditions and it will require staking and tying.

15 seed **A** \$3.95; 50 seeds **B** \$8.95; 100 seeds **C** \$16.10; 250 seeds **D** \$36.95

**2373 Red Robin Hyb. (55 Days)**

Great yields of 1 1/4" extra sweet red cherry tomatoes. This small plant is perfect for pots and containers. Suitable for growing indoors all year. Determinate.

Pkt. 25 seeds **A** \$5.25; 250 seeds **B** \$38.00; 500 seeds **C** \$68.40

**2376 Black Cherry (80 Days)**

Perfectly round with a sweet yet rich and complex flavour. Yields abundant crops of huge clusters of 1.5 cm (1 in), deep purple, mahogany brown cherry tomatoes. A very unique tomato variety. Staking type.

Pkt. 25 seeds **A** \$5.25; 250 seeds **B** \$22.50; 500 seeds **C** \$40.50

30-40 tomatoes per stem!

**2400 Rapunzel Hyb. (70 Days)**

Long, cascading stems with up to 40 small, round, bright red, 3/4 to 1 ounce cherry tomatoes on each stem. Excellent for growing in containers and staking or caging is recommended to support the weight of the fruiting stems. Indeterminate.

Pkt. 15 seeds **A** \$4.95; 50 seeds **B** \$9.95; 100 seeds **C** \$15.95

ROMA TYPE



2378 Amish Paste (83 Days)
One of the absolute sweetest and creamiest tomato flavour you will ever taste! This paste tomato produces bright red, large, 8-12 ounce fruit that is juicy and meaty. Perfect for sauces, tomato soups or even ketchup! Staking.

Pkt. 25 seeds **A** \$4.80; 250 seeds **B** \$19.95; 500 seeds **C** \$35.90



Excellent For Salsa

2294 Sunrise Sauce Hybrid (60 Days)

Perfect for small gardens or large containers. High yields of 85-113 gr (3-4 oz) orange fruit are easy to peel, sweet and meaty like traditional romas. Can be eaten raw but the best flavour is achieved through cooking. Makes eye catching orange salsa and sauce. Ideal for home gardeners who want a lot of tomatoes at one time for preserving. Ht 1 m (3 ft). Determinate.

Pkt. 15 seeds **A** \$5.50; 50 seeds **B** \$16.75; 100 seeds **C** \$29.95



3166 Fusion Powder*

A much more concentrated version of microorganisms, enzymes and carriers to stimulate plant health and rejuvenate the soil. Fusion is highly recommended when you start new plants for its' high concentration of micro-organisms and enzymes that will protect the plant and provide a healthy soil.

280 grams **A** \$14.95; 2 or more \$13.95 each. 1 kilo **B** \$27.95



2391 Little Lanterns

A compact variety of Ground Cherry that is perfect for containers. The round orange fruit is enclosed in a papery husk and can be used in various recipes. Plant indoors and transplant when temperatures are warm. Harvest when husks loosen.

Pkt. 25 seeds **A** \$5.95; 100 seeds **B** \$16.95; 200 seeds **C** \$30.95



2370 Mamma Mia Hybrid (60 Days)

Mamma Mia is a meatier, firmer fleshed fruit, just right for a thick and rich spaghetti sauce, or for salsa and any other recipes requiring a rich tomato taste. Staking type.

Pkt. 25 seeds **A** \$5.50; 250 seeds **B** \$39.95; 500 seeds **C** \$71.90; 1,000 seeds **D** \$102.75

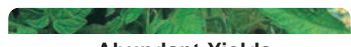

Abundant Yields



2369 Elizabeth (60 Days)

A family heirloom from Hungary. Mike Stefancsik of Lethbridge named this tomato after his mother. Produces 2 ounce, roma type, oval shaped tomatoes that are lightly speckled with gold stripes. Slightly sweet, but with good tomato flavour. Grows to over 10 feet and keeps producing huge numbers of fruit per plant--close to 300 fruit from 1 plant in our trials! Staking!

Pkt. 25 seeds **A** \$4.80; 250 seeds **B** \$19.95; 500 seeds **C** \$35.90

FEATURE ROMA



Italian Paste

2377 San Marzano (68 Days)

The most famous plum tomato to come out of Italy. Heavy yields of long, cylindrical fruit. Delicious, sweet flavour and low acidity, meaty pulp and deep red colour makes this tomato ideal for a great sauce! Intermittent, Vine Type.

Pkt. 15 seeds **A** \$5.50; 50 seeds **B** \$11.25; 100 seeds **C** \$20.25; 250 seeds **D** \$36.90

ORGANIC INSECT CONTROL!

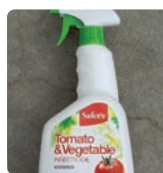

3360 Tomato & Vegetable Insecticide*

Kills insects on contact. Potassium salts (insecticidal soap) will weaken

the insect's protective outer shell. Pyrethrins attack the insect's nervous system. For control of aphids, mealybugs, spider mites, whitefly, soft brown scale, psyllids, rose or pear slugs and earwigs on house-plants, vegetable and fruits. Can be used right up to day of harvest!

1 litre RTU **A** \$17.50;
2 or more \$16.50 ea.

GROUNDCHERRY



I Am A Superberry

2388 Cape Gooseberry (80 Days)

This unique fruit has a brilliant orange colour with flavours of mango and cranberry. High in protein, this golden berry also contains high levels of vitamins! Use these berries as a refreshing fruit snack; bake into mixed berry crisps or pies; wonderful in jams and sauces for savory foods.

Pkt. 25 seeds **A** \$4.35; 250 seeds **B** \$13.35; 500 seeds **C** \$24.05

CURRENT TOMATO



Explosive Flavour



2382 Candyland Red Hybrid (60 Days) Currant Tomato

Smaller in size than cherry-type. This plant will produce a very high yield of 100+ tiny, dark red, sweet flavoured fruit that deliver bursts of flavour. Staking type.

Pkt. 25 seeds **A** \$4.55; 250 seeds **B** \$33.50; 500 seeds **C** \$60.30

FERTILIZER



3278 Tomato Fertilizer Spikes*

Handy fertilizer stakes will give you bigger and better tomatoes! Push stakes 2.5 cm (1 in) below the soil level on opposite sides of each plant (2 per plant), 20 cm (8 in) from the stem. One application lasts up to 8 weeks.

Each box 18 stakes **A** \$5.95;
2 or more boxes \$5.50 each

TOMATILLO



Supersized

2389 Super Verde (75 Days)

This special selection of tomatillo yields large, apple-green fruits. These medium sized plants need no staking. The globe shaped fruits reach 3-4 ounces, very large for a tomatillo, and the yields are very high. Fruit are firm, have strong healthy husks, attractive green colour and above average shelf life.

Pkt. 25 seeds **A** \$4.55; 100 seeds **B** \$11.60; 200 seeds **C** \$20.90



A Salsa Must

2386 Tomatillo Purple (65 Days)

This unique fruit is ideal for making Mexican salsa sauce. Ripe fruits are found in the dry papery husks that drop to the ground. When fully ripe these have a very pleasant fruity flavour with the purple being a bit sweeter and less tart than the green.

Pkt. 25 seeds **A** \$4.55; 250 seeds **B** \$9.95

STOP BLOSSOM-END ROT

BETTER GROWTH AND MORE TOMATOES!

KOZY COATS

SEED TAPE EASY PLANTING!



A Must For All Tomatoes

3280 Talk of Tomatoes (3-3-4)*

Stop "Blossom End Rot" which is caused by a lack of calcium when plants are not watered consistently. Apply when you transplant to the garden. 100% organic! Treats 24 plants.

720 gr (25 Oz) **A** \$21.95;
2 or more \$19.95 each.
2 kilo **C** \$48.95



3285 Organic Calcium (1-1-2)*

Evolve Calcium Essentials contains all the macro nutrients as well as 20% calcium. Essential for the elimination of "Blossom End Rot" in your

tomato production but also essential for all of your other indoor and outdoor plants. Simply apply near the base of the plant, cover with soil and then just water it in. It's that easy. Product covers 20 to 40 plants.

900 gr (32 Oz) **A** \$20.95;
2 or more \$19.95 ea

Boost Tomato Crops

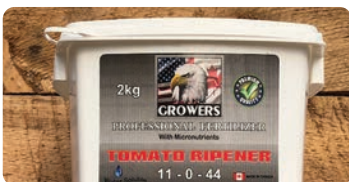

3255 Tomato Ripener (11-0-44)*

Apply when transplanting. Then every 10 days when flowers appear.

227 gram **A** \$14.50; 2 kilos **B** \$49.50



3810 High Yield Tomato Mulch*

More vigorous growth of your tomato plants and bigger crops (up to 46% more in research tests), roll out this high yield tomato mulch. 25-foot roll will do about 10 plants. (45cm/18 in wide).

Roll **A** \$12.95

LANDSCAPE STAPLES



3542 Landscape Staples*

Handy metal staples for keeping garden blankets in place. 15 cm (6 in) staples. Reusable. Ideal for both blanket and weed barrier!

Each pack (20) **A** \$6.50
Each pack (50) **B** \$17.50



3333 Crop Gain*

Flowers need to be pollinated sufficiently otherwise the fruits may become misshapen. Crop Gain helps in attracting pollinators to flowers of various crops. More visits will result in better pollination, better fruit set and bigger crop. Use Crop Gain on a variety of crops in your garden: beans, blueberries, cantaloupe, cucumbers, peas, peppers, pumpkins, raspberries, squash, strawberries, tomatoes and zucchini to name a few.

- Attract pollinators for better fruit set.
- Non toxic to insects & plants.
- Pesticide free.
- High concentration means less packaging.
- Easy to use.

50 ml **A** \$12.50; 2 or more \$11.95



Kenora, Ontario. April 24th 2017
Tomatoes survived -6 to -8 weather!

3800 Advanced Kozy Coats*

These new and improved Kozy Coats, will help you produce bountiful early crops regardless of the weather. The red colour keeps the tubes of water warmer longer, which means cozier Tomatoes, Cucumbers, Peppers and Melons, during chilly nights and even frost down to -12 C. And best of all - they work! Can be left on all-season, but keep filled with water.

2 Kozy Coats **A** \$14.95;
6 pak Kozy Coats **B** \$34.95

3805 50 Pak Kozy Coats*

Get at least one month head-start on the competition! Kozy Coats are treated with UVI (ultra-violet inhibitor) for long life (up to 10 years or more). Get a head-start producing pickling cukes, too!

50 Kozy Coats **A** \$250.00
(save 7% off regular price).



3802 Kozy Coats Repair Sleeves*

Do you have some old Kozy Coats with a leaky tube or two? Just insert a

plastic repair sleeve into the leaky tube and fill with water as usual. Works just like new!

10 sleeves **A** \$5.50

No Need to Thin!



2600 Beet Seed Detroit Dark (58 Days)

Resistant to bolting, this is the best variety for early sowing. It produces perfect globe Beets of excellent quality and colour.

Pkt. 5 m (15 ft) **A** \$5.95 each



2605 Carrot Seed Scarlet Nantes (65 Days)

An excellent old time favourite! Will produce heavy crops in late summer and early autumn. Roots have fine colour and have a very sweet, tender flavour.

Pkt. 5 m (15 ft) **A** \$5.95 each



2610 Onion Seed Tape Annual Bunching (60 Days)

One of the most desired varieties for bunching Onions. This 5 m (15 ft)

tape will make your rows perfect and save you time on thinning.

Pkt. 5 m (15 ft) **A** \$5.95



2615 Seed Tape French Breakfast (25 Days)

Our most popular variety, placed in a tape to give you an early maturing,

tender, mild Radish.

Pkt. 5 m (15 ft) **A** \$5.95



2620 Leaf Lettuce Seed Grand Rapids (45 Days)

The most popular variety for outdoor planting, greenhouse or cold frame. Light green, curly leaves with great taste. Early to produce and tip burn resistant.

Pkt. 5 m (15 ft) **A** \$5.95

2630 Seed Tape Collection

One each of the above
5 Seed Tape packets. **A** \$27.50

GREENS

Sweet & Crunchy



1350 Mei Qing Choi (40 Days)

This dwarf Shanghai Pac Choi is tender, sweet, and crunchy. Short, compact plants are slow to bolt. Perfect for growing through early spring to late fall, very cold-tolerant, for a surprisingly long harvest season. **Prices below**

LEMON GRASS



1345 Lemon Grass

A real delicacy, superb when used for cooking and added to pastas, sauces and salads. Its lemony flavour stands up to prolonged cooking, making it perfect for slow cooked meals. Lemongrass easily infuses into teas, soups or stock. Also used for perfume, oil and medicine.

1355 Minuet Hyb. Cabbage (48 Days)

Tender with a more delicate, light, sweeter taste than usual green cabbages. 22 cm (9 in) x 18 cm (7 in) heads with dark green outer leaves and an attractive yellow interior. **Prices below**

Prices for these greens

100 seeds **A** \$4.80; 500 seeds **B** \$11.25; 1,000 seeds **C** \$20.25

DAIKON RADISH

1360 Alpine Oriental (55 Days)

Smooth, attractive roots – white with green shoulders, and 15 cm (6 in) long. A better choice than the long types for rocky soils and better flavour, especially in warm weather. For fresh use, pickling, and storage. Mild flavour when compared to other radishes.

100 seeds **A** \$5.25; 500 seeds **B** \$12.25; 1,000 seeds **C** \$22.05



The New "Spinach"



1375 Tatsoi (21-45 Days)

Also called Spinach Mustard, Spoon Mustard, or Rosette Bok Choy, is a Asian variety of Brassica Rapa grown for greens. Leaves form a compact, thick rosette. Long harvest period. Mild flavour. **Prices below**

Use In Stir-Fries!



1352 Joi Choi Bok Choi (50 Days)

Grown for its stalks, which are used in Asian cuisine. It is also delicious raw. Each plant bears 10-14 erect stalks, 40 cm (15 in) tall.



EGGPLANT

Italian Type



828 Nadia

828 Nadia Hybrid (70 Days)

Long oval dark glossy purple-black fruit 20 cm (8 in) long by 8-10 cm (3-4 in) diameter. Tall, sturdy plants can set fruit under cool conditions. Excellent keeper! Italian type, more uniform diameter and great for stuffing and baking! **Prices below**



824 Shoya Long

824 Shoya Long Eggplant (60 Days)

This popular Japanese eggplant variety grows up to 35 cm (14 in) long. The fruit is slender with purplish-black colour. Early, productive, and fine-quality long eggplant. Stir-fry, grill or use in tempura.

Pricing for 824, & 828

Pkt. 25 seeds **A** \$5.30; 150 seeds **B** \$11.95; 300 seeds **C** \$21.50



1348 Asian Delight Pak Choi Hybrid (37 Days)

A Chinese cabbage that outperformed the comparisons by leaps and bounds. This Pak Choi does not bolt like the comparisons, even weeks after other varieties went to seed. That means the yield from this AAS Winner can be double or even higher than that of other Pak Choi on the market. Asian Delight forms small to mid-size 12-18 cm (5-7 in) heads that have a tasty, tender white rib and dark green, textured leaves. This is the best white stem mini Pak Choi we have ever seen!

Pkt. 100 seeds **A** \$4.80; 500 seeds **B** \$9.95; 1,000 seeds **C** \$14.50

Up To 50 Fruit On A Single Plant!



822 Patio Baby (60 Days)

Very early and highly productive with a compact habit, making it a great choice for containers or in the garden. Rich deep purple, egg-shaped fruit that should be harvested at baby size - 4 to 5 cm (2 to 3 in), and they are delicious roasted or in dips and salads. Plants will continue to produce fruit throughout the entire season.

Pkt. 15 seeds **A** \$5.30; 50 seeds **B** \$15.75; 100 seeds **C** \$28.35

ORGANIC SPROUTS & MICROGREENS

Certified organic seeds from a family owned Canadian grower and supplier!

Customer Favourite!



5606 Broccoli Brassica Blend
Contains broccoli, broccoli raab, green kale, radish, mustard, arugula. This sprouting mix has high levels of sulforaphane, a cellular detoxifier.

100 grams **A** \$9.25;
500 grams **B** \$31.50

5611 Sandwich Booster
Bring your sandwich to life with this terrific blend of clover, alfalfa, radish and mustard! Homegrown sprouts are a healthy addition to any salad or sandwich year-round. An easy 5-day sprout that grows well in a jar or sprouting tray.

125 gr **A** \$8.75; 500 gr **B** \$24.50



5615 Cilantro
Full cilantro flavor in a wonderfully tender micro-green. Cilantro is one of the easiest to grow. Effective in helping reduce the cholesterol levels in the blood.

100 gr **A** \$6.75; 500 gr **B** \$24.50



5614 Sunflower
Delicious nutty sunflower taste in a big crunchy microgreen!

75 grams **A** \$5.45; 500 grams **B** \$14.50

Give the Gift of Growing!

Gift cards never expire and can be used for any of our products in-store or online. Just choose the amount and add it to your order. It's as simple as that!

5602 Alfalfa

An easy 5-day sprout! Alfalfa sprouts are the only plant that offers a complete range of vitamins: A, B complex including B12, C, E, and K. It is also full of calcium, folic acid, magnesium, phosphorus, potassium, sodium, and zinc.

125 grams **A** \$9.25;
500 grams **B** \$23.25



Wheatgrass

1 oz of wheatgrass juice has the nutritional value to 2 1/2 lbs of the choicest vegetables and contains 92 minerals.

5616 Wheatgrass

Use for sprouted wheat bread, milling, juicing or short sprouts. A great source of chlorophyll, amino acids, minerals, vitamins, and enzymes. Eat them as sprouts, or grow a little longer and harvest for wheatgrass juice.

125 grams **A** \$5.45; 500 grams **B** \$9.95; 1 kilo **C** \$13.25



5621 Micro Green Salad Mix

A unique and wonderful blend of peas, fava beans, buckwheat and sunflower. You will love how well this blend grows together. A great lettuce replacement during winter months!

125 grams **A** \$4.55;
500 grams **B** \$10.95

Please note: Due to size of packages, Speciality Sprouting seed does not qualify for \$5.75 shipping.



Pea shoots are packed with Vitamin A, C and Folic Acid. Try adding them to a wrap!

5617 Speckled Peas

These are our recommended peas for growing tall pea shoots. Sweet 4-6 inch shoots. Great as a salad topper!

125 grams **A** \$4.95; 500 grams **B** \$9.75



5603 Lentils - Large Green

An excellent source of vitamins A, B, C, and E, calcium, iron, niacin, phosphorus and magnesium. Like many legumes, lentils have sugars that create intestinal gas. Sprouting helps break down some of those sugars.

275 grams **A** \$10.20; 500 grams **B** \$29.40

SPROUTING AIDS



5624 The Wonders of Sprouting*

An all new edition with updated information and beautiful colour illustrations. Easy and practical steps to grow sprouts in your home. It offers clear explanations, yet a lot of information for its small size. A fabulous resource for the novice sprouter.

Each **A** \$8.00



5628 Sprouting Lid*

Stainless steel ring and a stainless steel screen. Will fit any widemouth jar. To prevent smaller seeds from falling through the screen, please soak first. Best if you do not put in the dishwasher.

Each **A** \$4.95; 2 or more \$4.50 each



5629 Sprouting Jar 1 Litre*

A high quality jar with a stainless steel mesh lid. A nice product at an amazing price. *Please note that the natural pigmentation of the seed coating may leave "rust" looking stains on the lids. Significant testing has been done and be assured this is not rust. If this "rust" looking staining troubles you, take a small brush and scrub, but natural staining is normal.

Each **A** \$12.50

5599 Sprouting Blanket

Designed to save the muss and fuss involved in growing microgreens in soil, Sprouting Blanket is a felted jute grass mat that is processed by a water method and not treated chemically. Fits tray 3021 (1020 type) found on page 62.

Each **A** \$3.25



5612 Spicy Lentil Crunch

A mix of lentils, radish, alfalfa, red clover and mustard. Sprouting lentils increases the amounts of vitamins and minerals, especially B vitamins and carotene. Radish sprouts are rich in vitamin C.

125 grams **A** \$8.35;
500 grams **B** \$19.00



1808 Kids Miniature Pumpkin Mix (95 Days)

A spooktacular blend of mini pumpkins. These white, orange and striped pumpkins make a great addition to any fall or halloween display. The kids will love growing, harvesting, and displaying these charmers!

Pkt. 15 seeds **A** \$4.95; 50 seeds **D** \$12.25; 100 seeds **F** \$22.05



395 Kiddie's Variety Pak

Contains flower and veggie seed we've received from all over the world, many of which are not listed in the catalogue. Both fun and educational. For big kids as well as little ones!

Pkt. **A** 55¢ each; 5 for **B** \$2.50



4104 Kid's Grow Box

Do you know a kid who is an aspiring green thumb or super into science and learning how things work? We've got you covered. Everything they need for easy to grow plants, PLUS, a super cool microscope (page 70) for looking at bugs, soil, plants, and whatever else they can find!

Pkt. **A** \$28.95 each

Includes 6 varieties of easy to grow seeds. Seed varieties in photo subject to change. No requests or substitutions.

RAINBOW MIX VEGGIES!



392 Rainbow Mix Radishes

Vibrant radishes of purple, red, white and gold contain crisp, white flesh with a refreshing, tangy flavour! Pkt. 5 grams. **Prices below right.**



375 Rainbow Mix Beans

A delightful mix of purple, green, yellow and roma type beans. This tasty blend will be perfect for the "little gardener" to grow for eating fresh or for mom and dad to pickle! Pkt. 50 grams. **Prices below.**



390 Rainbow Mix Baby Lettuce

A full range of lettuce; romaine, red leaf, green leaf, butterhead, and head type for colourful and enticing salads! Pkt. 250 seeds. **Prices below right.**



385 Rainbow Mix Carrots

A blended mix of purple, red, and orange carrots to colour up your salads. Pkt. 7 grams **Prices below.**

GIANT SUNFLOWER



2275 Russian Giant (95 Days)

Add a colourful background or wind- break to your garden. These bright sunflowers make a large head that provide a huge number of seeds that are highly nutritious. Dry the seed, remove the husk and eat them yourself, the seeds and petals are edible. Ht: 3 m (10 ft).

Pkt. 10 grams **A** \$4.55; 25 grams **E** \$10.95; 125 grams **F** \$16.75; 500 grams **H** Pkt. \$28.95



380 Rainbow Mix Beets

Visually stunning variety beet mixture, different rich coloured beets! Red, cylinder, bull's blood, white and gold. Pkt. 7 grams. **Prices below.**

The above 5 Rainbow Varieties are also available in the Collection below.

When ordering individual packages, use the number beside each name. Individual Pkt. Various Sizes **A** \$4.35

399 Rainbow Collection

One each of the above 5 packets **A** \$17.95



Super Freak Fun!

1870 Pumpkin Knuckle Head 105 Days)
Spectacular warping makes them the star of the show! Produces perfect 7 kg (15 lb) distorted pumpkins for some halloween fun! Guaranteed conversation starter for table decorations or smaller Jack O'Lanterns.
Pkt. 10 seeds **A** \$5.45; 50 seeds **B** \$22.25; 100 seeds **C** \$40.05; 200 seeds **D** \$80.10



A324 Gremlins



GIANTS FOR FUN!

1885 Atlantic Giant (120 Days)
Developed by Howard Dill of Windsor, Nova Scotia, this Pumpkin has been known to grow over a 1000 pounds. Get your neighbours together and have a competition to see who can outgrow each other! Special instructions included.
Pkt. 10 seeds **A** \$5.45; 25 seeds **B** \$13.75

*Manitoba residents: these items taxable

FREAKS & GIANTS - FEED THE WHOLE TOWN!



"Peanut" Squash

2145 Galeux D'Eysines (100 Days)
A highly decorative, heirloom squash that makes for delicious eating. This flattened, round 4.5-7 kg (10-15 lb) fruit has a gorgeous salmon-peach coloured skin that is covered with large warts! The sweet orange flesh is used in French cuisine and also can be baked. We are delighted to offer this French heirloom.
Pkt. 25 seeds **A** \$4.55; 100 seeds **B** \$17.65; 250 seeds **C** \$42.35

Gremlins for the Garden!

A324 Gremlins Gourd
These "freaks of nature" are beautiful ornamental gourds bright, bold, and crazy with warts. Small to medium-sized 12-18 cm (5-7 in) gourds! Various solid and speckled vibrant colours, in a multitude of desirable shapes; stars, wings, acorns, mushrooms, necks and more. Ideal for the kids to grow and enjoy some halloween fun!
Pkt. 10 seeds **A** \$5.25; 50 seeds **B** \$20.95; 100 seeds **C** \$37.70; 200 seeds **D** \$62.95



1250 Giant Watermelon

1250 Giant Watermelon (100 Days)
This giant variety holds the world record! Melons can easily reach 100 kg (220 lb) with average care. Very flavourful crisp bright red flesh. The rind is striped and resistant to bruising. Challenge your gardening friends to your own contest!
Pkt. 10 seeds **A** \$6.25; 25 seeds **B** \$14.25

BABY CORN



Great in pots!

590 Cutie Pops (100 Days)
Up to 40 "pinkie" size ears, perfect for stir-fries or pickles and as crunchy finger food. Baby sized corn is 4 inches long with multi-hued kernels. Great for miniature popcorn and ornamental wreaths. Pick before silks turn brown. Seed is small.
Pkt. 5 grams **A** \$4.35; 25 grams **E** \$8.80; 125 grams **F** \$17.75

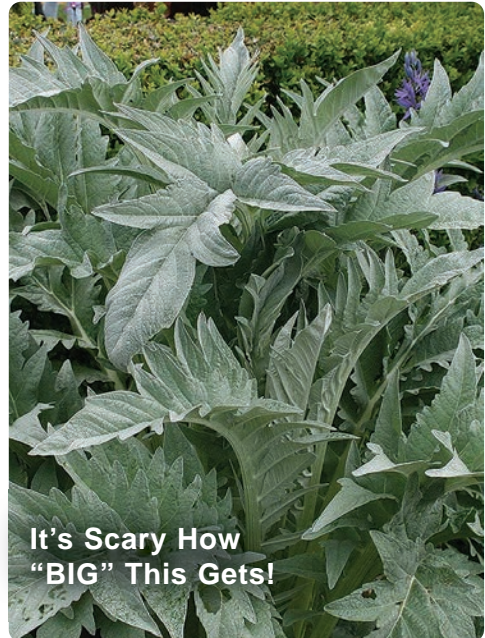

It's Scary How "BIG" This Gets!

10 Cynara Cardoon
Cardoon is an architectural splendor with bold texture, thanks to its large, prickly, almost dagger-shaped gray-green arching leaves and a statuesque, vase-shaped frame. An old fashioned vegetable that's enjoying a comeback. Cardoons are grown for their crisp, succulent leafstalk which can be blanched the same way as celery. Plants will reach up to 1.6 m (5 ft) tall and 1.2 m (4 ft) wide and you won't believe how many honeybees flock to the flowers. A close cousin of the artichoke. An absolute standout in any garden!
Pkt. 20 seeds **A** \$5.00; 100 seeds **B** \$14.25

GREEN MANURE COVER CROPS

Plant these GMO free green manure cover crops to add valuable nutrients to your soil. When ready to plant veggies, flowers, etc. simply dig the green manure into the soil. This will revitalize your soil!

Green Manure Crops do not qualify for \$5.75 Shipping



**NON
GMO**

195 Forage Radish

A very popular cover crop! Growers planting them are seeing benefits beyond commonly used cover crops, such as rye and clover. With taproots that can grow several feet deep, forage radishes bore holes into the ground, that loosen the soil, hence giving them the nickname "tillage radishes." The deep roots penetrate many layers of compacted soil, with the thin lower part of the taproot reaching 6 feet or more during the fall. After the cover crop dies in the winter and roots decompose, open root channels can be used by subsequent crop roots to grow through compacted soil layers.

500 grams to 5500 sq ft.

125 gram bag **A** \$10.15; 500 gram **B** \$13.25; 1 kilo **C** \$23.85



190 Buckwheat

A great quick summer crop! Fast-growing plants choke out weeds and the bees love the nectar-rich flowers that appear in 4-5 weeks. The tender stems are easy to cut down when the crop is done. Young leaves may be added to salads. The deep root system of buckwheat is good at mining subsurface minerals.

500 grams to 500 sq ft. – prices below

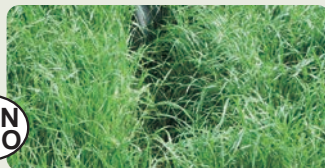

175 Annual Ryegrass*

Grows very rapidly and easy to till into the soil. Excellent for providing winter protection.

500 gm to 1000 sq ft. - prices below

180 AC Greenfix*

Still available! See Web Site! www.ttseeds.com

Pricing for above 3 Green Crops (175, 180 or 190) one type only per size.

500 gram bag **A** \$10.15; 2 kilo **B** \$27.95; 4 kilo **C** \$50.30



**NON
GMO**

200 Sugar Beets

Sugar beets are an increasingly popular food plot choice for wildlife enthusiasts, who are finding that they tend to draw deer by the dozens. Sugar beets also make a great crop for growers looking to add another feed source for livestock. Sugar beet tops can also be used as silage as a source of protein, carbohydrates and vitamin A.

500 grams to 700 sq ft.

125 gram bag **A** \$15.15; 500 gram **B** \$27.95; 1 kilo **C** \$50.30



169A Garden Mix Cover Crop
Our cover crop mix includes legumes, grasses, and black oil sunflower to provide organic matter, nutrients, and nitrogen fixation for healthier soil and pastures. **\$24.95**



Replacement parts available upon request.

3401 Fertilizer Applicator



3400 Precision Garden Seeder with Hemp plate*

Take the backache out of planting your garden. This simple machine opens the ground, plants the seed, covers and packs the soil all in one easy operation. Comes complete with 6-easy change seed plates: carrots, beans, corn, peas, radishes and beets (all will do similar size seed crops also). Planting depth is adjustable and it also marks out the next row at the same time. Light weight and easy to manage.

Each **A** \$249.95

3401 Fert-A-Ply Fertilizer Applicator*

Attaches to the precision seeder for easy application of granulated fertilizers. An improved model that gives you the ability to apply fertilizer to both sides of the row while planting. It allows you to side dress your planting and still use the row marker, it has 4 settings for fertilizer output and is easy mounting over the rear packing wheel.

Each **A** \$119.50

REPLACEMENT PLATES

3405 Original Plates Kit*

Replace your old seed plates with a new set of standard plates that include:

- Sweet Corn with a 7.2/18.3cm spacing.
- Radish, Leeks, Spinach with a 3/7.6cm spacing.
- Carrots, Lettuce, Turnips with a 4.5/11.4cm spacing.
- Beans, Small Peas with a 3.6/9.1cm spacing.
- Jumbo Peas with a 3/7.6cm spacing.
- Beets, Okra, Swiss Chard with a 3.6/9.1cm spacing.

Each Replacement kit (6 original plates) **A** \$65.95 each

3412 Optional Seed Plates*

Optional Seed Plate set gives you a variety of additional seed plates for many other plants, they include:

- Light Carrot with a 4.5/11.4cm spacing.
- Broccoli with a 1/2.5cm spacing.
- Cucumbers with a 9/22.9cm spacing.
- Popcorn with a 9/22.9cm spacing.
- Lima beans with a 12/30.5cm spacing.
- Blank seed plate.

Each kit (6 plates) **A** \$65.95 each



170 Subterranean Annual Clover*

Subterranean clover is a low-growing annual that forms a dense cover due to a low growth habit and extensive stolons and leaves. This makes sub clover an excellent weed suppressor, even better than vetch or even commercial herbicides. Perfect for large garden walkways! Sub clover makes an excellent green manure crop and will raise up levels of Nitrogen, making it very useful as a short rotation cover crop. Should be mowed as soon as it starts flowering to avoid it from reseeding. 500 grams will cover 3,000 sq ft.

250 grams **G** \$12.95; 500 grams **H** \$23.90; 2 kilos **J** \$54.95; 4 kilos **L** \$98.90

*Manitoba residents: These items taxable

GARDEN TOOLS AND AIDS

**3771 Soaker Hose***

- Very efficient watering with minimal run-off, uses up to 70% less water.
- Flexible, kink resistant, and very easy to handle

- Ideal for vegetable gardens, shrubs, flower beds, and walkways.
- Flat design makes it easy to roll up and store after use.
- 50 feet long.

Each **A** \$32.95**3780 Bypass Pruner***

Bypass pruners prove to be the most effective shearing tool when a precise cut is needed. The soft and delicate parts of plants require smooth and even cuts to heal and grow fast. Other types of pruners can leave the branch or stem crushed. With a bypass pruner, you get a chance to get as close to where you need to cut as possible.

- Lightweight cast aluminum handle with vinyl coating.
- Material: Polished SK5 blade .
- Size: 6 inches.

Each **A** \$15.50**3776 Garden Gloves**

- Sold in a 4 pack (2 of each colour).
- Latex coated, polyester liner.
- Knit wrist protection to keep out dirt and debris.
- One size fits all.

Each **A** \$10.95**3779 Floral Snips Pruner***

- Chrome plated blade for rust resistant smooth cutting.
- Lightweight cast aluminum handle with locking clip and finger protector bar.
- Material: SK5 Steel.
- Size: 6 inches.

Each **A** \$16.50**FUSION**
All Natural Fertilizer & Soil Stimulator

- The bacteria neutralize existing pesticides and herbicides in the soil to re-establish the natural bacteria and fungi balance in the soil.
- Fusion has proven effective at reducing the need for fertilizers, pesticides and herbicides.
- Fusion will suppress potato beetles, wire worms, caterpillars, aphids and other insects naturally.

3165 Fusion Liquid*

A natural fertilizer for use on plants, gardens, flowers and on soil. Fusion contains natural elements including live micro-organisms, digestive enzymes that help to rejuvenate all type of soils that show a lack of natural elements. The leaves will grow healthier, bigger and have a nice shine. When you add fusion to your soil the micro-organisms will eliminate toxic material, larvae and other insects. Add fusion directly in the soil or on the leaves.

500 ml RTU **A** \$15.95; 2 or more \$14.95 each. 4 Litre RTU **B** \$99.95**3166 Fusion Powder***

A much more concentrated version of micro-organisms, enzymes and carriers to stimulate plant health and rejuvenate the soil. Fusion is highly recommended when you start new plants for its high concentration of micro-organisms and enzymes that will protect the plant and provide a healthy soil. Fusion is also used to clean water for small ponds and used to treat larger gardens. After using fusion powder, we recommend that you spray the leaves with fusion liquid.

900 grams **A** \$16.50; 2 or more \$15.50 each. 1 kilo **B** \$30.95Visit our web site: www.ttseeds.com**GRASS SEED****9950 All Purpose**500 g **F** \$8.25; 2 kg **E** \$31.95; 5 kg **D** \$75.95**9952 Kentucky Blue Grass**500 g **D** \$10.95; 2 kg **A** \$39.95; 5 kg **B** \$97.95**9953 Deluxe**500 g **F** \$10.50; 2 kg **D** \$38.95; 5 kg **E** \$95.95

NEW & NOTABLE



Black Oyster

The flavour is complex, with notes of sweetness and umami flavour. The black oyster mushroom has a peppery aftertaste, so they go great in soups, stews, veggie stir fries, pasta or risotto dishes. Due to its meatiness it can also be used as an alternative to meat or poultry.



Lion's Mane

Most people equate the taste of this mushroom to that of lobster or crab meat, with earthier overtones. Lion's mane is tender and juicy when cooked, and it's often used as a seafood replacement in vegan recipes.



Pink Oyster

These delicate oyster mushrooms taste like bacon or ham, and their flavour intensifies when cooked. A meat-like flavour and succulent texture makes these mushrooms a wonderful meat substitute in many dishes.



White Oyster

White Oyster Mushrooms have a subtle flavour with a meaty texture. They are ideal for frying, for soups, or stir-frying. This makes them ideal companions for salads, pasta, and other dishes.



Blue Oyster

Blue oyster mushrooms definitely have a meaty or savory flavor, like many mushrooms. Some people say that blue oysters have a mild seafood flavor.



Chestnut

Chestnut mushrooms, also called Cinnamon Cap mushrooms, consist of bunches of mushrooms containing a small golden or chestnut brown cap with pink to dark brown gills and a thin white or beige stem. Lovers of this mushroom are drawn to its earthy and nutty taste.

Harvest Organic Mushrooms in Just Weeks 🍄 More Substrate = Higher Yields 🍄 Additional Harvests Are Possible

NL01 Mushroom Grow Kits

If growing mushrooms is something that you've always wanted to try, there's no better time to start than right now! Even if you live in an apartment, you have enough space to start growing your own delicious and nutritious mushrooms and growing your own mushrooms at home is easy to do. This kit comes with everything you need to get started and harvest your first crop of organic mushrooms. Comes with a ready to grow Mycelium block, spray bottle & a Beginner's Grow guide. Harvest organic mushrooms in just weeks!

Black Oyster **NL01A**; Pink Oyster **NL01B**; Lion's Mane **NL01C**; White Oyster **NL01D**; Blue Oyster **NL01E**; Chestnut **NL01F**; Choose your kit(s) \$32.95

ORGANIC SOIL ADDITIVES



3264 Blood Meal*

Contains 1% iron to darken up your plants. Use blood meal on all outdoor plants, garden areas, bulbs, trees and shrubs. A big problem in gardens and containers is nitrogen leaching out of the soil through rain and watering. This is a longer-lasting organic high-nitrogen fertilizer that will help keep foliage green and lush. Solves the "Petunia yellows."

Each 2 kilo bag **A** \$22.95



3261 Bone Meal*

Looking for additional phosphorus? Bone meal is easy for plants to take up and will help your flowering plants grow bigger, with more blooms, plus it will promote exceptional root growth. For roses, peonies, tulips, dahlias, cannas, etc. and vegetable root crops. Must be applied at root level.

Each 2.5 kilo bag **A** \$22.95

A VALUABLE RESOURCE!



3469 The 2024 Prairie Garden*

There's a tiny hummingbird flitting round the patio trellis, looking for the nectar from the red mandevilla cascading from its planter high on the trellis wall. The hummingbird can be considered symbolic of our Prairie summer: it is beautiful in the sun, as delicate as some of our summer flowers, and most of all, a fleeting presence. In addition to those beautiful brief summers, we must also contend with long, dark, and often stormy Prairie winters, and so we need to look at bringing our gardening activities indoors.

The late summer flowers – including echinacea, rudbeckia, and the oh-so-fragrant phlox – are in full bloom. It seems like just yesterday that the kaleidoscopic tumble of early summer flowers, featuring irises, peonies, and Asiatic lilies followed by daylilies, had just begun. When you walk out the door, the summer and early-fall heat wraps around you like a warm blanket. But remember: it never lasts too long. Get ready to curl up on the couch during winter storms with a different type of blanket – the newest edition of *The Prairie Garden* – and learn how you can garden indoors and out, all year-round. Each book **E** \$19.95

ORGANIC PEST CONTROL



3416 Waspinator*

If wasps are hijacking your outdoor fun, it's time for the Original Waspinator. This is the non-toxic, pesticide-free way to keep nuisance wasps from buzzing around patios, balconies, picnics, and campsites. Wasps won't come near an enemy wasp nest, so the Original Waspinator works as a deterrent by mimicking one. No chemicals, no clean up, no maintenance and no wasps!

Each **A** \$15.50; 2 or more \$14.50 each

*Manitoba residents: these items are taxable

PERENNIAL SEED

Easy to grow! Deer Resistant, Sow seed anytime!

ACHILLEA



B5 Colorado Mix

Mix of blood red, cerise, cream, yellow and white. All the good traits of yarrow, but in an irresistible blend of colours. The large flower clusters are in reality made up of scores of tiny daisies that last a long time and bloom until frost. Ht 45-75 cm (18-30 in). Deer resistant.

Pkt. 100 seeds **A** \$5.25; 500 seeds **B** \$17.50

RUDBECKIA



B65 Goldstrum-Black Eyed Susan

A great centerpiece to any garden bed! Masses of golden yellow, daisy like flowers with a distinct dark brown center cone. Long blooming! Ht 60 cm (24 in). A splash of gold for your garden!

Pkt. 25 seeds **A** \$4.95; 200 seeds **B** \$21.00

CLOVER



A4 White Dutch Clover

Often-requested perennial ground cover. Easily spreads and will provide small white flowers for an attractive meadow-like look! Ht 5 cm (2 in). Approx. Coverage; 250 grams will sow 2000 sq/ft, 5 kilos will sow 1 acre.

Pkt. 25 gram **A** \$4.95; 250 grams **B** \$19.00; 1 kilo **C** \$34.55



A12 Prairie Purple Clover

Purple prairie-clover is easily recognized by its cone-like flower heads. The flowers attract honey bees, bumble bees and other pollinators and add nitrogen back into the soil. Ht 30-90 cm (12-36 in).

Pkt. 50 seeds **A** \$4.35; 250 seeds **B** \$9.75

FEATURE PERENNIAL ECHINACEA



Bold Flower Display

B113 Cheyenne Spirit

Winner of both the highly coveted fleuroselect gold medal and an all-america selection. Cheyenne spirit is now ready to make its plant debut! They bounce back after wind or rain, need very little water to thrive, and will bloom all season long without deadheading. In short: a gardener's dream come true! This stunning first-year coneflower captures the spirit of the north american plains by producing a delightful mix of colors from rich purple, pink, red and orange tones to lighter yellows, creams and white. Ht 45-75 cm (18-30 in).

Pkt. 5 seeds **A** \$5.25; 25 seeds **B** \$22.50; 50 seeds **C** \$40.50

Spray on weekly - Organic Seaweed

Boost up the quality of all plants! Contains natural growth boosters, amino acids and loaded with micro-nutrients. Spray on weekly, you will see the results!

3249 Pre-Mixed Liquid Seaweed Concentrate*

500 ml of concentrate makes 37 litres or 8 gallons of fertilizer. 500 ml bottle **A** \$16.95; 1 litre bottle **B** \$26.95; 4 litre bottle **C** \$89.50

HOLLYHOCKS



Bright Jewel Tones



A194 Old Fashion Mix

Old fashioned single flowered mix. A wonderful garden full of rich memorable shades! Pink, red, yellow, white, burgundy and rose. Sturdy plants grow to (4-6 ft) tall and bloom over a very long season. The flowers will attract hummingbirds and butterflies. Plants will usually reseed and return year after year. A perennial in zones 3 and above.

Pkt. 50 seeds **A** \$4.70; 200 seeds **B** \$10.75



Plants labeled "Frost Hardy" can be planted outside a month earlier than normal after being hardened off.

Annual Flower Seed

"A" Flowers

Look for "A" before catalogue number (eg A44 Early Splendor). Scatter seeds directly into flower beds for quick, easy masses of colour.

Cut flower	Bee Friendly
Foliage/Contrast plant	Deer-resistant
Attracts Butterflies	Heirloom
Will Grow in Containers	

"B" Flowers

Look for "B" before catalogue number (eg B48 Nova Mix). Start these in trays in bright windows or under lights 6 - 8 weeks before outdoor planting.

Full sun
Semi-shade
Shade
Edible



All-America Selections Winners are new garden varieties of flowers, vegetables and plants that have been tested and proven to be superior for home gardening.

AMARANTHUS



A44 Early Splendor

A brilliant foliage plant with crimson upper leaves that look ready to burst into flame. Lower leaves are deep chocolate and crimson. These 1 m (3 ft) plants will be a showpiece!

Prices below



A45 Love Lies Bleeding

A very novel ornamental plant. Ropes of red blooms trail from the 90 cm (3ft) striking plant. Prices below



A49 Perfecta Tri-Colour

Vibrant red, yellow, and green foliage that lends a tropical effect to the garden. Also known as 'Chinese spinach' the leaves of the amaranthus species are used as an edible leafy green and are rich in minerals and vitamins! Mature ht 1.5 M (5 ft).

Pkt. 100 seeds **A** \$3.80;
500 seeds **B** \$7.65

ASTER



BEAUTIFUL CUTFLOWERS!

B330 Aster - Powder Puff Mix*

Double blooms 8-10 cm (3-4") in diameter, grow upright on long sturdy stems that will make amazing bouquets! Grows to a height of 60 cm (24") and will spread 15 cm (6").

50 seeds **A** \$4.95; 250 seeds **B** \$9.95



B48 Nova Mix

The largest flower in the Spider type Asters! The 10 cm (4 in) double quilled blooms provide an excellent show and are ideal for cutflowers. Wide ranging mix made up of nine different colours. Ht 50 cm (20 in).

Prices below with B50



B50 Milady Mix

A unique, dwarf, 20 cm (8 in) aster. Free-flowering by midsummer and blooming into fall.

50 seeds **A** \$3.60; 250 seeds **B** \$7.65

FLOWER MIXES

A6 Deer Resistant Mix

This annual and perennial mixture is a blend of garden flowers and wildflowers that are known to be resistant to deer browsing. Keep in mind that if natural food supplies are low, or local populations of deer are dense, even these plants may be browsed by deer. Includes bergamot, blue sage, poppies, four o'clocks, foxglove, french marigold, gaura, yarrow, lavender, lemon mint, perennial lupine, larkspur, alyssum and sweet william pinks. (25 Grams will cover approx. 250 Sq ft of garden). Prices below



A7 Bee Feed Mix

A blend of nectar and pollen flowers for honey bees, native bees, bumble bees, and other pollinators. This is a mix of low maintenance perennials and reseeding annual wildflowers. (25 Grams will cover approx. 150 Sq ft of garden). Prices below

A10 Bird & Butterfly Mix

A choice blend of over 20 different flowers that provide seeds and nectar to songbirds, hummingbirds and butterflies! Includes cornflower, candytuft, coreopsis, godetia, sage, larkspur, lupine, california poppy, black-eyed susan and many more! (25 Grams will cover approx. 150 Sq ft of garden). Prices below



FEATURE PERENNIAL MIX



A5 T&T Perennial Mix

24 Lovely perennials in this special blend including blue flax, columbine, gloriosa daisy, echinacea, sweet william, gailardia, viola, dianthus and many more! (25 Grams will cover approx. 250 Sq ft of garden). Excellent sowing in late fall too!

Prices below

A30 Wild Flower Mix

A mix of 26 perennials and annuals species of native and naturalized flowers of western canada. (25 Grams will cover approx. 500 Sq ft of garden). Prices below



Prices for A5 to A30 Mixes

Pkt. 1 gram **A** \$3.75; 5 grams **B** \$9.95; 25 grams **C** \$21.65;
125 grams **D** \$59.00

ALYSSUM

A36 Carpet of Snow

The ideal plant to edge your flower bed. Makes a neat trim border. Low, compact and sweetly scented.

Pkt. 250 seeds **A** \$4.00;
1,500 seeds **B** \$9.75



Enjoy the sweet smelling perfume of Alyssum



A36 Carpet of Snow

A39 Easter Bonnet Mix

A delightful combination of pastel shades from lavender and pink to white. Uniform in colour and form, noted for its earliness. Compact 10 cm (4 in) plants.

Pkt. 250 seeds **A** \$4.35;
1,500 seeds **B** \$12.30

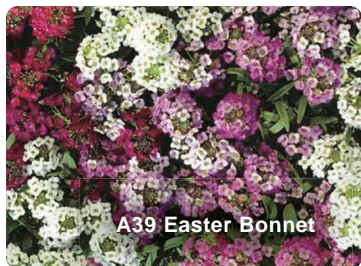

A39 Easter Bonnet

BACHELOR'S BUTTON

BELLS OF IRELAND



A126 Frosty Mix

Mix of blue, wine-red and white but all are tipped lightly in white! Plants are excellent for cutflowers. Plant height is 30 cm (12 in) and spreads 30 cm (12 in).

Pkt. **A** \$3.75; 5 grams **B** \$9.95



A52 Bells Of Ireland

A very unique and attractive plant that has been in cultivation since the 1500s. Great for drying and arranging. Ht 60 cm (2 ft).

Pkt. **A** \$4.35; 5 grams **B** \$9.95

Made in Manitoba

5126 Bee Balm*

This beeswax salve is a soothing and moisturizing treatment for rough, dry skin. A protective creme made from extra virgin olive oil, beeswax and Vitamin E. Unscented.

28 gram tin (2 oz) for **A** \$10.95;
2 or more \$9.50 each



Natural Pain Control!

5420 Serrapeptase*

What is Serrapeptase? Serrapeptase is used for painful conditions including back pain, osteoarthritis, rheumatoid arthritis, osteoporosis, fibromyalgia, carpal tunnel syndrome, and headaches. Enteric-coated Serrapeptase is made from an enzyme that removes blockages that impede your natural healing ability.

Serrapeptase can be thought of as a natural pipe cleaner for your body to dissolve arterial plaque, blood clots, cysts, and inflammation. If you are using NSAID drugs for inflammation or pain, but worry about their harmful side effects, Enerex Serrapeptase is a highly effective and proven natural alternative, but always check with your health care provider first.

60 Caps 60,000 units **A** \$33.95;
60 Caps 120,000 units **B** \$49.95

(Enerex Toll Free Information
Line 1-888-411-1988)

FEATURE CASTOR BEAN

Amazing results with our Seaweed and Rose & Strawberry fertilizer!



B110 Red

A steady diet of Rose & Strawberry Fertilizer with liquid seaweed brought about these amazing results! The plants were over the rooftop of customers house! Fed every two weeks and this is what happened! Photo sent in by N.Dubchak of Winnipeg.

B110 Red

Here's a handsome plant with spectacular leaves and even more spectacular red seed pods that will knock your socks off (unless you're barefoot). Ht 2 m (6 ft).

15 seeds **A** \$7.55; 50 seeds **B** \$21.25; 100 seeds **C** \$38.25

Warning: Leaves and seed of Castor Bean are poisonous.

B111 Ricinus

Largest green leaf variety, reaches 3m (10 ft). These plants are excellent as a background or providing quick dense screening.

CELOSIA

Great in containers and attracts honeybees



A121 Celosia Dracula

Novelty celosia shows one big flower atop the plant. Unusual shape and eye-catching colour add drama to landscapes, gardens and containers. Ht 20-40 cm (6-10 in) spreads 20-30 cm (8-12 in).

15 seeds **A** \$5.25; 50 seeds **B** \$18.95; 100 seeds **C** \$34.10



A120 Celosia First Flame Scarlet

Electrifying, red plumes with feathery spikes cluster tightly above bright olive-green foliage! Creates a continuous show of colour. This is the ultimate heat-loving, drought-tolerant annual you MUST try this year! Ht 35-45 cm (14-18 in).

Prices below with A119



A122 Celosia - Brainiac Mix

Early flowering, heat tolerant, and compact. Densely crested, 5 cm (3 in) combs show up and show off in hot, vibrant colors. Very well-suited for use in landscapes, mass plants and mixed containers. Mature ht 15 cm (6 in).

15 seeds **A** \$5.50; 50 seeds **B** \$10.50; 100 seeds **C** \$17.95



A119 Celosia First Flame Purple

Perfect for containers or as a border plant. The intricate design of the flame shows little flowers bound tightly together to resemble a flame shaped flower. Ht 25-35 cm (10-14 in).

25 seeds **A** \$4.35; 250 seeds **B** \$15.90; 500 seeds **C** \$28.60

COSMOS

Great Cut Flowers!



A165 Double Click

A Fleuro Select winner in 2007! This impressive mix will produce semi-double to fully-double flowers all summer long! Blend of white, pink and carmine flowers on vigorous 120 cm (4 ft) plants. Ideal as a background planting.

Pkt. 25 seeds **A** \$4.35; 100 seeds **B** \$9.25; 500 seeds **C** \$18.95



A170 Dwarf Cosmic Mix

A steady performer in the garden. Compact plants, 30 cm (12 in) high, with vibrant colour and very free flowering. Lacy green foliage make the plants ideal for mass plantings or containers too!

Pkt. 25 seeds **A** \$4.35; 100 seeds **B** \$9.25; 200 seeds **C** \$16.65



A172 Seashells Mix

Blooms in creamy and pastel white, pink, rose and carmine. Blooms are 7 cm (3 in) across and are lightly rolled like seashells. Bright, daisy-like blooms on 90-120 cm (36-48 in) stems with ferny leaves.



A168 Dwarf Sensation

At last, the beauty of cosmos without staking! Easy to grow and quick to flower from seed. Blooms in shades of pink, carmine, pink blush and white on compact 60 cm (2 ft) plants. Excellent in beds and borders!

Prices for A168 & A172: Pkt. 75 Seeds **A** \$4.35; 500 seeds **B** \$9.25

FEATURE COSMOS



A173 Candy Stripe

A very unique cosmos-attractive large white flowers tinted with a crimson picotee edge and rich golden center. No two blooms are alike, varying in intensity and hue! Excellent cut flower that will attract birds and butterflies. Simply beautiful! Ht 1 m (3 ft).

Pkt. 75 seeds **A** \$4.35; 500 seeds **B** \$9.25

Simple, Yet Elegant!



A174 Dazzler

An amazing addition to any flower garden with its bold carmine blooms! Gorgeous in flower beds and borders. It also makes a superb cut flower with a vase life as long as 7 to 10 days. Height 90-120 cm (36-48 in). with a spread of around 35cm (14 in).

Pkt. 75 seeds **A** \$4.35; 500 seeds **B** \$9.25

CALENDULA



A65 New Bon Bon Mix

Dwarf and early flowering, very uniform 7 cm (3 in) flowers provide a cheery blend of bright yellow, orange, delicate apricot and soft yellow. Ht 30 cm (1 ft).



A76 Candy Man Yellow

Known for its beauty and medicinal qualities, the calendula is a widely adored flower throughout the world. In any garden, the vibrant faces are sure to please! Ht 30 cm (12 in).

Prices for above Calendula A65 & A76

Pkt. 75 seeds **A** \$4.35; 500 seeds **B** \$10.50

Edible and will help attract pollinators to your garden

Manitoba customers: flower seed is taxable

ASCLEPIAS

Save the Monarch Butterfly



B8 Butterfly Milkweed

B8 Butterfly Milkweed

Milkweed is an important host plant for Monarch Butterflies, and they provide nectar to a wide range of butterflies, moths and bees. This bushy, 45-60 cm (18-24 in) perennial is prized for its large, flat-topped clusters of bright-orange flowers. Non-invasive variety. (Tuberosa).

Pkt. **A** \$4.35; 200 seeds **B** \$8.95



B9 Carmine Rose

B9 Carmine Rose

Prized for attracting Monarch Butterflies! Nice for cutting, and the blooms are long-lasting in fresh and dried bouquets, produces large number of showy flat-topped clusters of beautiful rose coloured blooms. Plant height is 90 cm (3 ft).

50 seeds **A** \$4.35; 200 seeds **B** \$8.95

MATTHIOLA

Small blooms close in daytime, open towards evening, filling the air with perfume. A few patches tucked in corners will scent the whole area around the home. No garden is complete without Matthiola!



A478 Dwarf 10 Week Cascade

This early variety forms dwarf compact plants that are excellent for edging or low beds. The sturdy foliage is greyish-green with dense spikes covered with rosette blossoms in soft colours. Excellent cut flowers. Ht 30 cm (12 in).

Pkt. **A** \$3.75; 2 grams **B** \$7.65



A326 Night Scented Stocks

Small lilac-coloured blooms .Ht 30 cm (1 ft). Grows quickly from outdoor seeding.

Pkt. **A** \$4.35; 2 grams **B** \$8.80

PTILOTUS



Show Stopping Display!



B293 Ptilotus Joey

This unique beauty has the benefit of being heat and drought tolerant too! Large, conical spikes of feathery flowers top the thick silver green foliage. The 7-10 cm (3-4 in) flower spikes are glistening silver with a darker neon pink color near the tips. Use as an accent in mixed pots and containers or as a compliment in your annual flower beds.

Pkt. 10 seeds **A** \$8.25; 50 seeds **B** \$35.75; 100 seeds **C** \$64.35

ORNAMENTAL PEPPERS

B75 Red Onyx

This is one of those stunning plants that steal the show! An ornamental pepper adorned with eye-catching dark black foliage. The contrast between the diminutive black foliage and tons of shiny red fruits is striking and makes a bold statement in the garden. A wonderful plant for beds, borders, containers and dramatic mass plantings. Edible. Ht 18-25 cm (7-10 in).

Pkt. 15 seed **A** \$7.25; 50 seeds **B** \$24.50; 100 seeds **C** \$44.10



Sweet Pepper

B72 Chilly Chili

This small compact pepper plant produces upright, pointed, 5 cm (2 in) sweet peppers that range in colour from the early greenish yellow, to orange, to a fully ripe red. The mix of warm colours on this plant all at once, creates the illusion of small fires erupting on top of the these compact plants. Ht 25 cm (10 in).

Pkt. 15 seed **A** \$5.75; 50 seeds **B** \$19.00; 100 seeds **C** \$34.20



B71 Black Pearl

Unique pure black leaves when grown in the full sun, and it also describes the shiny peppers that are similar to pearls! Young plants start out green, but will quickly darken when transplanted out to the full sun. Easy-to-grow, the plants have a mature height of 45 cm (18 in) and will spread 40 cm (16 in). And oh yes, these peppers are edible, but fiery hot!

Pkt. 15 seed **A** \$7.25; 50 seeds **B** \$19.95; 100 seeds **C** \$35.90

GERANIUMS



B131 MaverickWhite

**Geranium Pricing
Prices for All Geraniums**

Pkt. 10 seeds	A	\$5.95
25 seeds	B	\$9.75
50 seeds	C	\$17.75
100 seeds	D	\$35.10
250 seeds	E	\$66.15
500 seeds	F	\$119.05

Save!

Buy any 2 or more

A size packets
\$5.15 each.

"Maverick" Series

Multiple stems with early large flowers make this Geranium series irresistible!

B131 White B140 Red B141 Violet

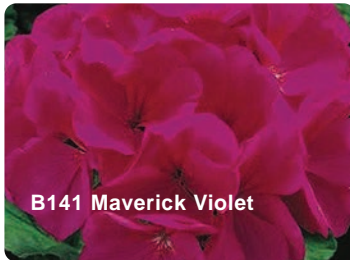

B141 Maverick Violet



B140 Maverick Red

Geraniums - perfect for any hot spot that calls for a splash of vibrant colour throughout the season.



Improved Colour!



B133 Maverick Orange
First true-orange hybrid seed geranium. Large flower heads, very free flowering. **One of our top sellers!**



B136 Scarlet Picotee
Bold balls of pleasant scented white flowers with coral-pink overtones and scarlet edges. Delicate scarlet blooms.

LAVATERA



A255 Pink Blush

A new dwarf type lavatera! The gorgeous large white flowers have delicate pink striation providing a pleasing bloom. Very easy to grow! Compact plants 40 cm (16 in) are excellent as a border or in mass plantings. Also ideal for containers. Contrasting rich green foliage.

Pkt. 50 seeds **A** \$4.80; 500 seeds **B** \$14.50

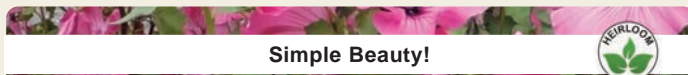

Simple Beauty!



A270 Silver Cup

A mass of vivid pink blooms cover these very robust shrub-like plants. Blooms freely from July to frost. Good cut-flower. Ht 60 cm (2 ft).

100 seeds **A** \$4.25; 500 seeds **B** \$9.95

GAZANIA



B132 New Day Mix

Short-stemmed daisy-like flowers in many vivid bright colours over the silvery green leaves. Frost tolerant. Ht 22 cm (9 in).

Pkt. 25 seeds **A** \$5.10; 100 seeds **B** \$10.95; 200 seeds **C** \$19.70



A200 Paper Daisy - Giant Double

Bright, yellow-eyed, papery daisies. First-rate flowers for cutting and drying. Known as everlastings; blooms retain their colour and form indefinitely when dried. When old flowers are removed, paper daisy will flower all summer. Ht 60 cm (2 ft).

100 Seeds **A** \$3.75;
500 seeds **B** \$8.35

IMPATIENS - THE PERFECT SHADE PLANT!

MIMULUS

FOUR O'CLOCKS

Eye-Catching Jewel Tones!



B145 Beacon Mix

Fill your gardens once again with bright, long-lasting colour. New beacon impatiens offers **high resistance to impatiens downy mildew**. For lasting colour, you can rely on beacon to thrive. Ht 25-30 cm (10-12 in).

25 seeds **A** \$4.70; 100 seeds **B** \$12.25; 250 seeds **C** \$19.95; 500 seeds **D** \$35.90; 1,000 seeds **E** 71.80



B185 Accent Mix

B185 Accent Premium Mix

Vibrant flowers put on a gorgeous display from spring all the way to late summer and add great colour to the garden. Ultimate hanging basket series. With very large flowers and extra vigor, knockout baskets may be grown. They are also an excellent choice for mass planting-where they will surely create a super bright mass of colour. Garden height: 35 cm (15 in).

Prices with super elfins at bottom



B174 Red



B171 Rose

"Super Elfins"

Improved giant Super Elfins produce profuse uniform blooms on dwarf 15-20 cm (6-8 in) plants.

B171 Rose

B174 Red

B185 Accent Mix

B155 Red Starburst

Prices for all above Impatiens

- 25 seeds; **A** \$4.70
- 100 seeds **B** \$9.85
- 250 seeds **C** \$15.50
- 500 seeds **D** \$27.90
- 1,000 seeds **E** \$55.80



B112 Magic Mix

A bright and colourful blend of dwarf 25 cm (10 in) plants that are excellent in pots, hanging baskets and borders. Blooms in only six weeks. Excellent under lights indoors.

Pelleted seed.

Pkt. 25 seeds **A** \$4.35;

200 seeds **B** \$8.80



A274 Bi-Colour Mix

More than one colour of flower can appear on the same plant. Mixed colours, all flowers splashed or marbled in cherry-red and pink. Makes a nice low hedge 50-70 cm (20-28 in) tall. Blooms open in the afternoon and the scent attracts hummingbirds, bees & butterflies.

Pkt. **A** \$4.70; 10 grams **B** \$11.25

DUSTY MILLER

ORNAMENTAL CORN



B97 Silver Dust

Retains compactness through the summer; more intense silver than other strains. Outstanding edging plant! Ht 20 cm (8 in).

Pkt. approx. 300 Seeds **A** \$4.35;

1 gram approx. 3,000 seeds **B** \$9.75;

Pelleted 1,000 seeds **C** \$14.50



A225 Pink Zebra

Unusual variegated leaves have ribbons of green, white, yellow, and hot pink. The tassels are dark purple and the kernels are burgundy red. Grows 4-6 feet tall. Can be grown in containers and are especially striking when paired with brightly coloured petunias or sweet potato vines.

10 seeds **A** \$7.15; 50 seeds **B** \$27.95

STRAWFLOWER



B360 Copper Red*

Tall, well-branched plants produce vibrant copper, double blooms 2-2 1/2" across. Makes a great addition to cut flowers or excellent for drying. Mature height 36-40".

50 seeds **A** \$6.95; 250 seeds

B \$10.95; 500 seeds **C** \$18.95

STOCKS



B117 Katz Cherry Blossom*

Edible, peppery, clove-like flavour use as a garnish on salads, desserts, and drinks. Early blooming, long stems with 1 1/2-2", pale pink blooms. Mature height 24-32".

50 seeds **A** \$6.7; 250 seeds

B \$10.95; 500 seeds **C** \$16.95

"JANIE" SERIES

MARIGOLDS - EVERYWHERE!



Unique petals



A282 Janie Orange

Early dwarf French Marigold. Blossoms average 2-3 cm (1 in) in diameter on 20 cm (8 in) plants. Coated seed.

A282 Deep Orange – Solid orange.
A283 Flame – Red and gold bi-colour.
A285 Bright Yellow – Bright yellow.
A286 Mix – Blend of 3 colours.

Pkt. 50 seeds **A** \$4.70; 250 seeds **B** \$9.75; 500 seeds **C** \$17.55



A280 Super Hero Spry

A popular favorite as well as a winner in trial gardens across the country. A truly beautiful and exceptional marigold with richly coloured burgundy and gold blooms on a compact 25-30 cm (10-12 in) plant. Super-easy to grow and a tireless bloomer!

50 seeds **A** \$4.70; 250 seeds **B** \$12.15; 500 seeds **C** \$21.85

"DURANGO" SERIES



Medium Height

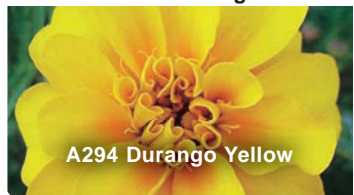

A294 Durango Yellow

Excellent branching with more blooms and uniform plants make this series a winner! Blooms will average 5 cm (2 in) in diameter on 30 cm (12 in) plants.



A292 Durango Flame



A295 Durango Mix

A292 Flame – Mahogany edged with orange.
A294 Yellow – Clear yellow.
A295 Mix – Blend of 8 colours.
A296 Bolero – Gold & red.

Pkt. 50 seeds **A** \$4.35; 250 seeds **B** \$10.35; 500 seeds **C** \$18.65

APPROXIMATELY 300 MARIGOLD SEEDS PER GRAM

"INCA" SERIES

"CRACKERJACK" SERIES



Tall Height



A319 Inca Mix

The first African Marigold that's day-neutral which means it produces huge masses of bloom even in early summer! Most Marigolds don't perform their best until August. Large 8 cm (3 in) flowers on 40 cm (16 in) plants.

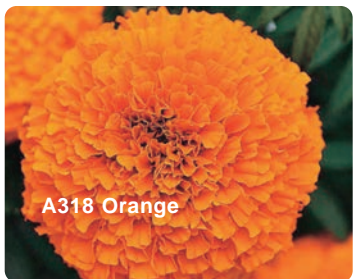

A318 Orange

A316 Yellow A318 Orange
A319 Mix - (above 2, plus gold)

Pkt. 25 seeds **A** \$4.70; 250 seeds **B** \$27.95; 500 seeds **C** 46.85



A304 Crackerjack Mix

Truly a king among Marigolds. Huge flowers in a full colour range. Perfect plants. Ht 60 cm (2 ft).

Pkt. **A** \$4.35; 5 grams **B** \$8.75; 125 grams **C** \$30.10

A315 All-Size Marigold Collection

Rich masses of colour in all sizes for both background and edging. Includes Crackerjack, Inca Yellow, Durango Flame and Janie Orange. 4 pkt. collection

Save \$\$ **A** \$14.95

All Marigolds can be directly seeded outdoors but you'll enjoy earlier flowers by starting indoors 6 weeks early. Seed some pots in June for placement in fading gardens in fall.



Carpet of Colour!

A289 Hot Pack Mix

A great choice for season long colour in a mass planting. Plants stay compact and continue to flower reliably even in locations with high temperature or high humidity nights. Ht 15-18 cm (6-7 in).

50 seeds **A** \$4.70; 250 seeds **B** \$10.95; 500 seeds **C** \$16.95



5133 Calendula Oil*

Gentle, cooling and soothing, Calendula is one of the most effective topicals for a wide variety of skin conditions. It heals dry and damaged skin, soothes inflammatory conditions such

as rash, diaper irritation and psoriasis, relieves pain and swelling, and helps fight infections. Exceptionally beneficial for anyone with sensitive skin and it makes a wonderful baby oil.

Each 50 ml Bottle **A** \$31.50; 2 or more \$29.50 each



5120 Ozsum Cream*

Ozsum topicals contain CBD infused coconut oil giving it analgesic properties that may relieve localized pain, muscle soreness, tension, and inflammation. It may be effective for the treatment of pain related to rheumatoid arthritis, tendonitis, and bursitis among other ailments. Ozsum cream can be used as post-workout pain relief for aching muscles and joints. It may be effective in treating symptoms for everything from psoriasis to cramping.

45 grams **A** \$46.75; 2 or more \$40.75 each

MARIGOLDS



"Big Duck" Series

A330 Big Duck Yellow



A336 Big Duck Gold



A335 Big Duck Orange

Featuring very large flowers that bloom throughout the season, much longer than others. When it starts blooming, watch out! Full, plump blooms top the 38 cm (15 in) plants and continue blooming through the end of the season. You'll want to use these everywhere!

A330 Yellow A335 Orange A336 Gold
Pkt 25 seeds **A** \$5.45; 100 seeds **B** \$15.75; 200 seeds **C** \$28.35



A322 Queen Sophia

Eye-catching! This french marigold has dark bronzy gold blossoms that mature to reddish gold. An AAS winner because of its distinctive, large, flat, bicolor blooms which put on a colourful show. Ht 30 cm (12 in).

15 seeds **A** \$4.95; 100 seeds **B** \$24.95; 200 seeds **C** \$44.95



A290 Strawberry Blonde*

Colour-changing French marigold, they open deep coral and then fade to lovely shades of cream and warm pink, then to gold. These marigolds are perfect for patio containers or as a border around a garden. The easy to grow Strawberry Blonde is heat tolerant and thrives in the sun! Mature height 20-25cm (8-10 in).

50 seeds **A** \$4.50 250 seeds **B** \$10.95; 500 seeds **C** \$16.95



A340 Garuda

A regal shade of orange in an extremely vigorous, cut flower type marigold. In the garden, it has cleaner foliage and overall larger flower size. In the vase, it is outstanding, lasting at least 10 days. Also makes a great hedge! Ht 90 cm (3 ft).

25 seeds **A** \$5.45; 100 seeds **B** \$15.75; 200 seeds **C** \$28.35

SNAPDRAGONS



B20 Saptini Mix

A classic compact look gardeners will love! Plants are 15-20 cm (6-8 in) tall. Starts blooming early, producing loads of jewel-rich blooms all season. 6 lovely colours. **Prices below**



B40 Madame Butterfly Mix

A mix of tall 70 cm (30 in) open-face "butterfly" type blooms, giving a fuller flower spike appearance.

Prices below



B25 Ribbon Mix

Bright colours will add height and texture to your garden. 45 cm (18 in) plants. **Prices below**

B20 Saptini Mix B25 Ribbon Mix B40 Madame Butterfly Mix
Pkt. 50 seeds **A** \$4.35; 250 seeds **B** \$10.75; 500 seeds **C** \$19.35

SPILANTHES



B305 Lemon Drop*

Bright, solid-yellow flower heads the shape of gum drops. Known as a toothache plant due to its analgesic properties. This numbing sensation arises from chewing either the flowers or leaves. Perfect for containers and bed plantings. Heat tolerant. Edible flowers have a spicy, citrus-like flavour, can be used as a garnish on ice cream and drinks.

50 seeds **A** \$5.95; 250 seeds **B** \$10.95; 500 seeds **C** \$22.95

GARDEN BANDIT

Customer Favourite



3885 Garden Bandit*

This handy weeding tool is incredibly strong. The curved stainless steel blade stays firmly fixed to the handle and slices through even the toughest soil. The comfortable power grip handle and sharp, curved stainless steel blade are key to the Bandit's precision. A quick sweep gets the job done while aerating soil. 30 cm long (12 in).

Each **A** \$18.95; 2 or more \$17.50 each.

MARIGOLDS - ZILLION SERIES (MINI)



Scented Foliage

A275 Lemon

A277 Red

A276 Tangerine

"Deer Resistant" Marigolds!

Zillions of dime-sized lemon yellow, tangerine or red flowers. This series produce compact plants with finely divided, lacy foliage and clusters of small, single flowers. The flowers of these marigolds have a spicy tarragon flavour. **The foliage has a pleasant lemon fragrance.** Excellent plants for edging beds and in window boxes. Ht 25 cm (10 in).

A275 Lemon Gem A276 Tangerine Gem A277 Red Gem
Pkt. **A** \$4.35; 1 gram **B** \$9.95

A278 Zillion Collection

One each of the above Gem packets. 3 pkts. **A** \$10.25

Manitoba customers: flower seed is taxable

NASTURTIUMS



A385 Baby Rose*

Versatile, bright, bold, and edible! They will creep through borders, climb through trellis, spill beautifully over walls, trail exotically from your hanging baskets, brighten up your vegetable garden and add a colourful twist to your salad! Ht 20 cm (8 in).

Pkt. 25 seeds **A** \$4.55; 100 seeds **B** \$13.25



Customer Favourite!



A390 Cream Purple Spot

Compact and elegant! Dwarf, bushy plants are covered in unique creamy, yellow blooms with dark purple central markings. These miniature plants are ideal for containers or small gardens. Both the leaves and brightly coloured flowers are edible! Ht 25 cm (10 in).

25 seeds **A** \$3.95; 200 seeds **B** \$12.95



A388 Black Velvet

The deepest, darkest, richest, ruby-black blooms grace tidy mounding plants that reach 30 cm (12 in). For a bold contrast, add blossoms to your fresh spring salads or cheese plates. Edible flowers and foliage are a gourmet treat reminiscent of peppery watercress in flavour.

25 seeds **A** \$4.25; 200 seeds **B** \$12.25

NICOTIANA



B166 Perfume Mix (Improved Heaven Scent)

Excellent free-flowering mix with the traditional Nicotina fragrance. This solid-coloured mix gets 40 cm (16 in) high and holds the flowers upright. **Pelleted seed.**

Pkt. 50 seeds **A** \$4.35; 200 seeds **B** \$9.95



B170 Old Fashioned Fragrance

More lovely than modern Nicotiana, this old fashioned variety has abundant branching sprays of pure white, sweetly perfumed flowers. 150 cm (5 ft) mature plants.

Pkt. 100 seeds **A** \$3.85; 500 seeds **B** \$9.95

A400 Glorious Gleam

Double flowers, delightful assortment of bright colours. Plants are semi-trailing or climbing, excellent for window boxes, flower borders or covering dry banks. Ht 60 cm (2 ft).



A400 Glorious Gleam

A395 Whirlybird Mix

Low mounded plants are covered with a mass of bloom. Flowers carried well above the foliage are semi-double and face upwards. Ht. 30 cm (1 ft).



A395 Whirlybird Mix

OSTEOSPERMUM



Asti Series

An amazingly versatile series that tolerates both heat and cold. Withstanding light frost, it is perfect for both spring and fall gardens. Huge, 6 cm (2 1/2 in) daisy-like blooms have shimmering white or purple petals beautifully offset the intriguing blue centers. Mature plant 50 cm (20 in).

B336 Asti Purple B335 Asti White

Pkt. 10 seeds **A** \$9.25; 50 seeds **B** \$35.75; 100 seeds **C** \$64.35



A399 Alaska Mix

Distinct creamy-white and green foliage makes this a delightful plant for rock gardens and any baskets. Ht 30 cm (1 ft).

All Nasturtium A size packets approximately 30 seeds.

Prices for above Nasturtiums (does not include A390 or A388)

Pkt. **A** \$4.35; 25 grams **B** \$12.15



A399 Alaska Mix

LOBELIA

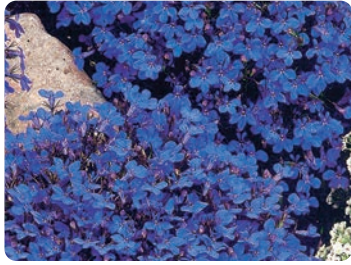

B161 Crystal Palace (Upright)
Very deep blue flowers on compact 15 cm (6 in) plants. Bronze leaves. Prices below.



B164 White Lady (Upright)
A bright clear white Lobelia on compact 15 cm (6 in) plants. Ideal for contrast in baskets. Prices below.



B163 Sapphire Trailing
Bright sapphire blue flowers with white eye. Trailing habit gives the finishing touch to window boxes, planters, hanging baskets, etc. Prices below.



B165 Colour Cascade Mix
A trailing mix of mid-blue, light blue, white, carmine, purple and other colours.

Prices for each
Lobelia (B161 to B165)
Pkt. **A** \$4.15; Tr. Pkt. **B** \$8.75

POPPY



A444 Flanders Poppy (Lady Bird)
The Poppy that inspired the Remembrance Day poem, In Flanders Fields. Blood red flowers with four black patches. The packet includes the 1915 poem and signature of the author, Canadian Dr. John McCrae. Ht 40cm (16 in).
Pkt. **A** \$4.35; Tr. pkt. **B** \$9.95



A440 California Poppy (Ballerina Mix) Large shiny flowers in a brilliant colour range, contrast against the bluish green leaves. Ideal for use in wildflower garden. Ht 25 cm (10 in).
Pkt. **A** \$4.35; 2 grams **B** \$8.75



A420 Lauren's Grape
Absolutely stunning chalice-shaped flowers with satiny petals that glow in the most delicious shade of deep ruby-purple. These outstanding, heirloom poppies grow .9-1.5 m (3-5 ft.) tall, depending on how rich your soil is. With their rich colour and big, lettuce-like, blue-gray leaves, this beauty will be the highlight of your spring garden!
Pkt 75 seeds **A** \$4.55; 300 seeds **B** \$9.55

CLEOME



B67 Sparkler Mix
A colourful blend of blush, lavender, rose and white will make it a great focal point in your garden! This heat-loving annual has 10-15 cm (4-6 in) spidery blooms that hummingbirds love. Also, deer tend to avoid cleome and you will want to be careful as the plant does produce thorns. Ht 90-120 cm (3-4 ft).
10 seeds **A** \$5.95; 50 seeds **B** \$17.95; 100 seeds **C** \$29.95

PHLOX



A477 Phlox of Sheep
Flowers in sprays and pastel shades including peach, pink, blush, vivid salmon, white and buttercream. Some flowers are solid while others are bi-colour. Stems lengthen over time, and blooms carry a sweet, sugary fragrance. Ht: 50-75 cm (20-30 in).
Pkt. **A** \$4.35; Tr pkt **B** \$8.75

VERBENA

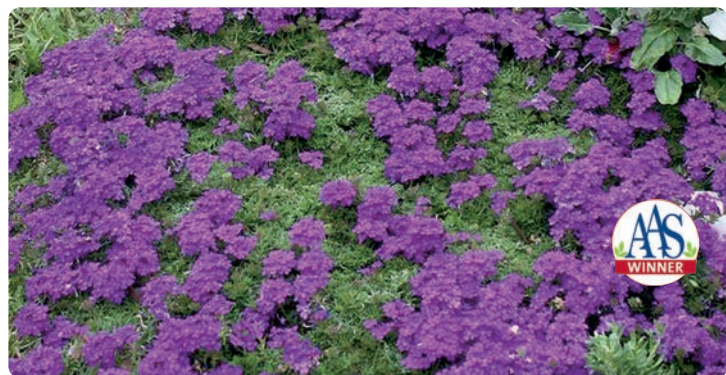

B300 Imagination*
Intense violet-blue flowers and beautiful lacy foliage make this easy to grow trailing plant an ideal choice for hanging baskets, containers, slopes or rock gardens. Blooms over a very long season, is heat and drought tolerant and virtually pest free. Grows to 30 cm (12 in) tall and 50 cm (20 in) across.
25 seeds **A** \$4.95; 100 seeds **B** \$13.95; 200 seeds **C** \$24.95

PANSIES



Frost Hardy & Edible Blooms!



B350 Cool Wave Pansy Mix

This plant trails more than 60 cm (2 ft) long, setting magnificent whiskered blooms every inch of the way! And it grows larger and faster than others, with a far bushier habit. Cool Wave is EASY...it has the most vigor of any spreading pansy, so less plants per pot are needed. Create incredibly unique and inspiring baskets that trail up to 60 cm (24 in).

Pkt. 20 seeds **A** \$9.95; 50 seeds **B** \$23.95; 100 seeds **C** \$43.10
250 seeds **D** \$89.50



B215 Mammoth Mix

Jumbo sized blooms on compact, well mounded plants. These beauties will deliver big, bold colour in your garden! Strong, branching plants will quickly fill out your planters. Ht 15-20 cm (6-8 in)

Pkt. 25 seeds **A** \$5.00
100 seeds **B** \$13.25
500 seeds **C** \$39.00

PENSTEMON



B310 Arabesque Red

The first ever penstemon to become an AAS Winner in more than 80 years. Beautiful red and white bi-colour unique large bell shaped flowers adorn well-branched plants that will attract both hummingbirds and butterflies all summer! Ht 40-60 cm (16-24 in).

20 seeds **A** \$5.75; 100 seeds **B** \$27.95; 200 seeds **C** \$50.30

PORTULACA



A452 Sundial Mix

A blend of white, peach, scarlet and mango shades. These large bright vivid flowers stay open longer! Ht 10 cm (4 in).

Pkt. 250 seeds **A** \$4.70;
1,000 seeds **B** \$10.75

CLIMBING PETUNIA



Scented and Climbing!

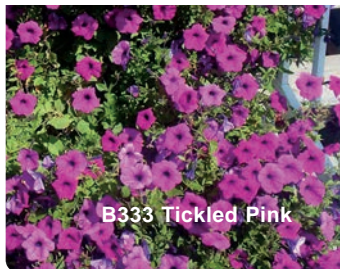

B333 Ticked Pink

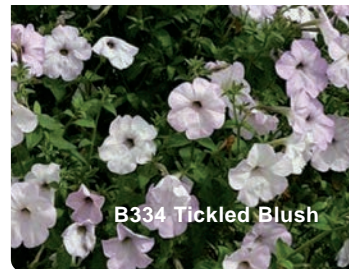

B334 Ticked Blush

A new type of vining petunia, has fragrant 5 cm (2 in.) flowers on plants with a climbing habit when grown on strings, trellis, or inside a wire support such as a tomato cage. Plant 2 to 3 of these petunias in a large hanging basket to form a marvelous draping curtain of colour. Vines can also be used as a ground cover. Plants will grow to approximately 180 cm (6 ft.) tall.

B333 Ticked Pink
B334 Ticked Blush

Your choice:

20 seeds **A** \$11.45; 50 seeds **B** \$21.35; 100 seeds **C** \$38.45;
250 seeds **D** \$69.95; 500 seeds **E** \$125.90



Scented Petunias

B210 Evening Scentsation

Only one thing could make a spreading petunia even more appealing, and this one's got it; FRAGRANCE! With notes of hyacinth, sweet honey and rose and as the name implies, the scent is stronger in the evening hours. It has a visual sensation too, with brilliant indigo 5 cm (2 in) blooms that billow from baskets or patio containers. Ht 12-20 cm (5-8 in) and a width of 75-90 cm (30-36 in).

20 seeds **A** \$11.45; 50 seeds **B** \$25.75; 100 seeds **C** \$46.35; 250 seeds **D** \$89.50; 500 seeds **E** \$161.10

Aids in damping off!



3160 Plant Wash Plus*

Just spray a fine mist on foliage and stems on all indoor or outdoor plants and watch your plants flourish. Also very good for aiding seedlings, will help in early stage health! Can be used on plants such as potatoes, tomatoes, cucumbers, grape vines to keep them healthy. Active ingredient .08% Akwaton, which is 99.99% effective against bacteria, fungi and spores.

1 Litre RTU spray bottle **A** \$17.50; 2 or more \$16.50 each

PETUNIAS



"SOPHISTICA" PETUNIAS - Frost hardy!



B291 Blackberry B289 Lime Bi-colour

These beautiful designer Petunias combine large blooms with unique and gorgeous colours! With a mounded growth habit of 24 to 36 cm (10 to 15 in) tall, will add elegance and interest to the garden from spring through frost. Suitable for pots, combo planters and baskets.

Pkt. 20 seeds **A** \$8.25; 50 seeds **B** \$19.00; 100 seeds **C** \$34.20; 250 seeds **D** \$69.95

For All Plants in Containers Add Directly To Soil

How do you keep your plants supplied with nutrients throughout their life? Easy! Slow-release fertilizers are designed to help with this. Our slow release fertilizer boasts a balanced NPK ratio of 14-14-14 and can be used to feed trees, shrubs, perennials, and heavy fruit producers like tomatoes, melons, and berries.



3263 Slow Release (14-14-14)*

Peter says: Mix this into the soil when planting. Slowly releases nutrients all season. A must for all containers.

454 gram **A** \$17.50; 2 kilos **B** \$44.95; 10 kilo bag **C** \$165.95



HYBRID "TIDAL waves"



B219 Tidal Wave Purple

Vibrant bright purple flowers are similar in colour to popular Wave Purple! Plants spread 1.2 m (4 ft) in a season and are covered with 5 cm (2 in) purple blooms, while maintaining low plant height of 45 cm (18 in). Excellent in containers!

B227 Tidal Wave Cherry

Rich cherry red blossoms! Use in mass planting or containers, ideal for overhanging garden walls. Plants spread 1.2 m (4 ft) in a season and are covered with 5 cm (2 in) cherry blooms, while maintaining low plant height of 45 cm (18 in).



B226 Tidal Wave Silver

Plants spread 1.2 m (4 ft) in a season and are covered with 5 cm (2 in) lavender blooms, while maintaining low plant height of 45 cm (18 in). Use as ground cover or in containers.



B234 Tidal Wave Red Velour

Dark blood red with velvety undertones and dark throat! Excellent foreground cover or in containers where the masses of 2" blooms cover vigorous growing plants that are 45 cm (18 in) tall and spread 1.2 m (4 ft).

Pkt 20 seeds **A** \$13.25; 50 seeds **B** \$31.30; 100 seeds **C** \$56.35; 250 seeds **D** \$93.50; 500 seeds **E** \$168.30

(Pelleted seed) Prices for Tidal Wave Petunias!

RUDBECKIA



B66 Amarillo Gold

Alluring large, gorgeous yellow blooms on a compact plant! Will make wonderful bouquet and is an excellent choice for growing in containers. Mature height is 33 cm (13 in).

15 seeds **A** \$5.50; 50 seeds **B** \$17.95; 100 seeds **C** \$29.95



B64 Cherry Brandy

Stunning, bright cherry-red flowers, 7-10 cm (3-4 in) across. An extended blooming season and a spectacular show in the garden when other plants are starting to fade. Ht 60 cm (24 in)

25 seeds **A** \$6.25; 100 seeds **B** \$17.70; 200 seeds **C** \$23.95

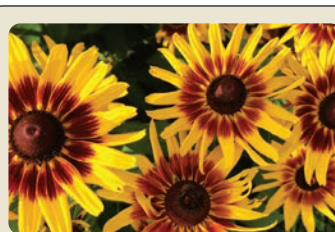

B60 Denver Daisy

Enormous 15-20 cm (6-8 in) blooms with outstretched petals of purest yellow. At the base of each petal is a dab or two of dark red, creating a halo around the chocolate-brown cone. Makes a stunning cutflower bouquet and a huge draw in the garden (butterflies, bees and songbirds take notice!) Ht 60 cm (24 in).

Prices for each Rudbeckia (B60 & B62)

Pkt. 25 seeds **A** \$5.00; 200 seeds **B** \$21.20

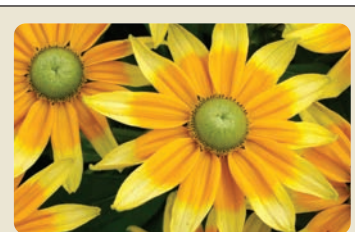

B62 Prairie Sun

Large shiny very distinct blooms made this beauty an AAS winner! The light green central cone blends seamlessly with the golden-yellow petals, which are tipped primrose yellow. Large 12 cm (5 in) blooms are displayed on strong 90 cm (3 ft) plants. Great for use in cutflower displays!

PETUNIAS

Hybrid Waves

B231 Carmine Velour
B235 Purple

Easy Waves

B237 Easy Wave Yellow
B239 Easy Wave Lavender Sky Blue
B240 Easy Wave Burgundy Velour
B242 Easy Wave Red
B244 Easy Wave White
B245 Easy Wave Blue
B246 Easy Wave Burgundy Star
B247 Easy Wave Neon Rose
B248 Easy Wave Rosy Dawn

Shock Waves

B316 Shock Waves Pink Vein
B318 Shock Waves Denim
B319 Shock Waves Deep Purple

***Pelleted seed ***

Prices for all Petunias on this page.

Pkt. 20 seeds	A	\$13.25
50 seeds	B	\$34.50
100 seeds	C	\$62.10
250 seeds	D	\$89.95
500 seeds	E	\$161.90

"Thrill, fill, and spill" is a phrase that's become popular in describing how to arrange a container garden.

- 1. Thrill:** This refers to the addition of a unique, eye-catching plant, one that usually has some height to it.
- 2. Fill:** This is exactly what it sounds like - selecting plants to fill out any remaining space in the container. You typically want to use shorter plants or flowers as to not take away from the height of the thriller.
- 3. Spill:** The final component of creating a great container garden is adding plants that spill over the edges.

HYBRID "WAVES"

The most popular petunia around.

Grow in flower beds for a great show, or perfect for baskets where their robust habit will give you an amazing flood of colour.
Height 15 cm (6 in)
Spread 60 cm (24 in)



B235 Purple Wave

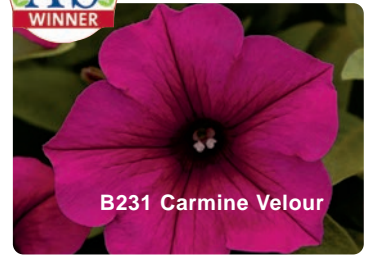

B231 Carmine Velour

Pelleted seed

All our petunia's are pelleted seed. These are seeds that have been covered with a coating that makes small seeds easier to handle and see.

HYBRID "EASY WAVES"

PETUNIA SEED GUARANTEE

We buy only top rated seed that has been tested. We will not replace seed on low germination complaints as this is an indication of improper conditions. Please be diligent and careful in your germinating process.

Slightly more compact than wave type. For small locations or more compact containers or anywhere you want to make a bold impression! Height 20 cm (8 in). Spread 50 cm (18 in)

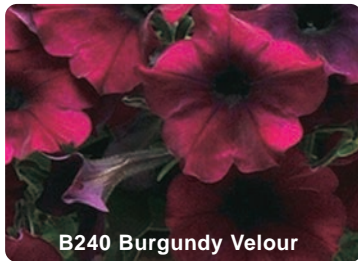

B240 Burgundy Velour

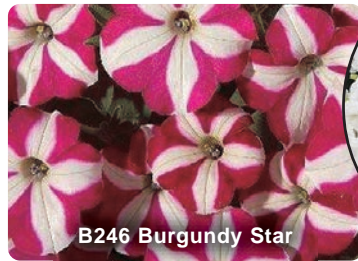

B246 Burgundy Star



B244 White



B242 Red

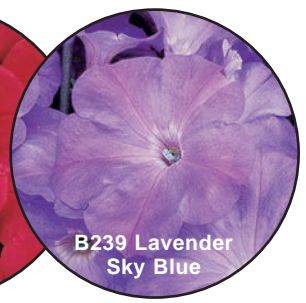

B239 Lavender Sky Blue



B245 Blue

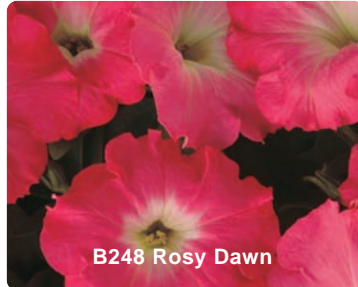

B248 Rosy Dawn

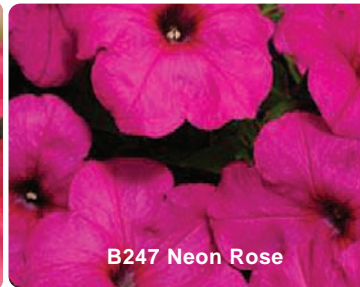

B247 Neon Rose



B237 Yellow

Ideal for small space gardens, containers and baskets! Compact plants produce an abundance of 4 cm (1 1/2 in) self-cleaning blooms! Ht 30 cm (12 in) and spread 60 cm (2 ft).

HYBRID "SHOCK WAVES"



B316 Pink Vein

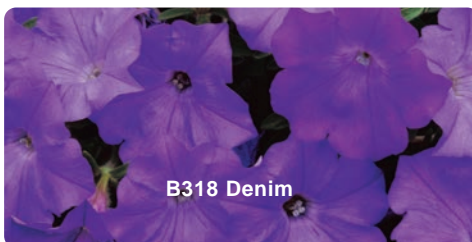

B318 Denim

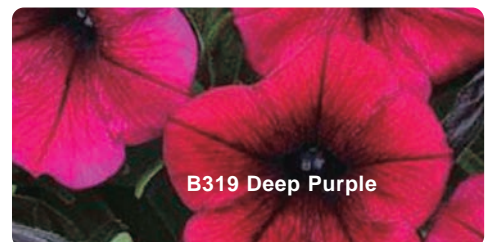

B319 Deep Purple

PETUNIAS

It's no wonder petunias continue to rank among the most popular flowering annuals. They're bright and lively, bloom from spring until frost, and scent the air with lovely fragrance. Planting petunias in containers is a fantastic way to showcase them. Whether in hanging baskets or containers, growing petunias in pots brings vibrant colour throughout the summer to whatever area you choose.

Petunia Pricing

Grandiflora and "Storm" Grandiflora pricing only. 2 columns on the right side of this page. All seed is pelleted

Pkt. 50 seeds	A	\$6.35
250 seeds	B	\$14.50
500 seeds	C	\$26.10
1,000 seeds	D	\$52.10

Buy any 3 or more A size packets \$5.00 each. Grandiflora and "Storm" Grandiflora only

FEATURE "DOUBLE" GRANDIFLORA



B225 Glorious Mix

B225 Glorious Mix
An attractive mix with a variety of colours including bi-colours. Large, fully double flowers. Excellent for mass plantings and large window boxes. Our most popular double! 30-35 cm (12-14 in). Prices below.



B223 Orchid Mist

Prices for above pelleted seed - Double Grandifloras only
Pkt. 50 seeds **A** \$5.70; 250 seeds **B** \$14.50; 500 seeds **C** \$25.95; 1,000 seeds **D** \$37.95

Grandiflora
Largest flowers, best in beds or containers. Large 10-12 cm (4 in) slightly ruffled blooms on 31 cm (1 ft) plants.



B276 Storm Mix - Blend of 8 storm colours.



B265 Daddy Mix - A mix of 6 "Daddy" types.



B241 Fire Frost
Rich red with white "frosted" edge.

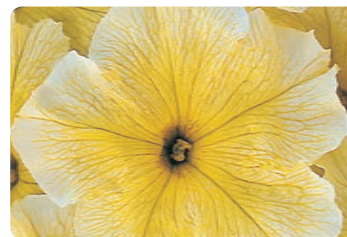

B275 Prism Sunshine
Rare rich yellow with darker veins, holds its colour.



B255 Super-Cascade Burgundy
Vivid burgundy.

"Storm" Grandiflora
Strong basal branching, non-stretching, compact habit. 30-35 cm (12-14 in) in garden. Quick to recover after rough weather!



B271 Pink Storm - Clear pink.



B273 Pink Morn Storm - Intense pink with yellow centre.



B274 White Storm - Pure white.



B267 Blue Storm - Solid blue.



B268 Red Storm - Rich red.

SUNFLOWERS



A495 Big Smile

A perfectly formed perky little sunflower! The dwarf 30-40 cm (12-15 in) plants will do great as a border, mass plantings or in containers. Blooms are bright yellow with brown center and will literally 'smile' up at you from the garden!

Pkt. 25 seeds **A** \$4.95; 100 seeds **B** \$12.20



A499 Dwarf Choco Sun

Possibly one of the smallest and quickest flowering sunflower available. The dwarf multi-flowering plants will produce their first blooms in 11 to 12 weeks from sowing. Lemon yellow flowers with dark chocolate brown centers over dark green leaves. Very compact, ideal for containers, window boxes and gardens. Plants will grow 1.25-1.5 m (4-5 ft). Ideal for adding interest to containers and fun for children to grow.

Pkt. 15 seeds **A** \$5.65; 100 seeds **B** \$21.25



FEATURE DWARF SUNFLOWER



A481 Dwarf Sunspot

Single, enormous flowers up to 30 cm (12 in) across on very short stems. Stout plants that rarely grow taller than 60 cm (24 in) makes for a very striking container plant, but will require regular feeding, and a fairly heavy base so that it doesn't get top heavy. The long lasting flowers produce copious seeds for wild birds to snack on.

50 seeds **A** \$5.00; 250 seeds **B** \$11.25

A Splash Of Sunshine



A489 Autumn Beauty Mix

Flowers in an array of autumn shades: red, yellow, gold, orange, russet and burgundy. These are a tough, fast growing sunflower that is useful as cut flowers and as a source of edible seeds. Blooms are 10-15 cm (4-6 in) and plant height is 1.5 m (60 in).

50 seeds **A** \$4.25; 250 seeds **B** \$11.25



A490 Soraya

The 10-15 cm (4-6 in) flowers are a standout on these robust 1.7 m (5 ft) plants.

Pkt. 25 seeds **A** \$4.95; 100 seeds **B** \$11.25



A480 Teddy Bear

Cushions of golden yellow flowers with tiny double petals and a dab of green for an eye! Very compact cute plants, 60 cm (2 ft) ht. Blooms are 10 cm (4 in) across.

Pkt. 25 seeds **A** \$3.75; 100 seeds **B** \$11.25



A494 Ruby

A Sunflower with attitude! Rich ruby red blooms standout! Plant as a backdrop or in mass for real show! 2 m (6 ft) ht. Blooms are 15 cm (6 in) across.

Pkt. 25 seeds **A** \$4.95; 100 seeds **B** \$15.75



A498 Sunrich Orange

No pollen! Orange-yellow petals with a black center. Medium blooms of 15 cm (6 in). Just 10 weeks after direct sowing, a whole bouquet of elegant, evenly sized, pollenless flowers can be cut for indoor decorating or bridal displays. Plants will grow 1.2-1.5 m (4 - 5 ft).

25 seeds **A** \$4.95; 100 seeds **B** \$13.95

Manitoba residents: Flower seed is taxable

SUNFLOWERS-CONTINUED



A491 Strawberry Blonde
No Pollen! Multi-coloured petals have lemon yellow tips with rosy centres. Tall, fast growing, and well branched plants have large blooms of 12-15 cm (5-6 in), will leave you speechless! Great for cut flowers.
Ht 1.5 m (4 ft).
25 seeds **A** \$4.95; 100 seeds **B** \$16.95



A620 State Fair Mix
Giant flowers, with terrific sun and heat tolerance. This giant Dahlia-like variety has blooms to 18 cm (7 in) and colours of pink, lavender, purple and yellow. Long flower stems on 75 cm (2.5 ft) plants.
Pkt. **A** \$3.95; 5 grams **B** \$9.95



A640 Coral



A645 Mix

FEATURE SUNFLOWER



A492 Florenza
The light yellow tips provide a lovely contrast with the rusty ring. Ideal as an attractive background or use it as a centre piece in large containers. Plants are 120 cm (4 ft) tall with 12 cm (5 in) blooms. A gardeners cutflower dream.
Pkt. 25 seeds **A** \$4.35; 100 seeds **B** \$9.95



A486 Ring of Fire
Sturdy dwarf plants produce large 15 cm (6 in) mahogany red with golden edged single blooms on 120 cm (4 ft) tall with attractive light green foliage.
25 seeds **A** \$4.95; 100 seeds **B** \$13.25

SWEET PEAS

A cottage garden classic producing beautiful blooms with the most gorgeous scent! These pea-like flowers grow in many lovely colours and are suitable for an annual border, a woodland garden, and a trellis or arch. Also beautiful in bouquets.



A535 Streamers Mix
All Streamers are delicately striped with white flakes, providing a very elegant bloom display. Mix made up of lavender, orange, chocolate, pink, scarlet and white. Easy to grow!
Pkt. 25 seeds **A** \$4.35; 25 grams **B** \$23.00



A530 Mammoth Mix
Blend of 10 different colours from the Mammoth Series. Enjoy a long season of beauty and fragrance.
Pkt. 50 seeds **A** \$4.35; 25 grams **B** \$11.45; 125 grams **C** \$29.85

"Mammoth" Series

Very fragrant large flowers on vigorous vines. Early flowers! Long stems make them perfect for cutting.

Individual Varieties

- | | |
|---------------|----------------|
| A501 White | A503 Crimson |
| A506 Lavender | A509 Rose Pink |
| A510 Scarlet | A512 Navy |

Price for above 6
Pkt Approx. 50 seeds **A** \$4.35; 25 grams **B** \$12.35

A520 Mammoth Collection

One packet each of the Mammoth Series varieties. Collection of 6 pkts. **A** \$20.95
Collections do not qualify for \$5.75 shipping.

Magellan Zinnia Series
These will attract all kinds of attention to your garden! The vibrant brightly coloured blooms are 15 cm (6 in) across on 45 cm (18 in) plants. Consistent flower size, form and plant uniformity will make these a winner in any garden! Coated Seed

A640 Magellan Coral
A645 Magellan Mix
Pkt. 15 seeds **A** \$6.85; 50 seeds **B** \$19.95; 100 seeds **C** \$35.90; 500 seeds **D** \$115.00

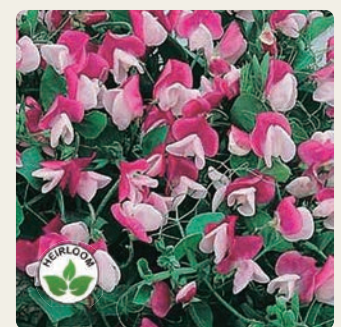

A505 Cupid Bush Sweet Pea
Perfect for displaying on patios, decks or in small space gardens. A very fragrant bush sweet pea, that looks lovely planted in containers or hanging baskets. The short vines grow 15 to 20 cm (8 to 10 in) tall, then flower in gracefully cascading stems of rose pink, picotee edged blossoms.
25 seeds **A** \$4.35; 200 seeds **B** \$12.35

ZINNIAS - THE ULTIMATE SUN PLANT!



These double-flowered Zinnias will be the envy of the neighbourhood, just waiting to transform your sunny garden into a sea of the brightest red, orange or deep pink! Blooms are 6 cm (2 ½ in) wide, and pop up all over super-compact plants, drawing bees and butterflies into the garden. Zinnias are one of the easiest flowers to grow with the most return! Ht 30 cm (12 in). With a 30 cm (12 in) spread. Coated seed.

A672 Double Fire A674 Brilliant Mix
 Pkt. 25 seeds **A** \$4.70; 100 seeds **B** \$17.50; 500 seeds **C** \$54.95



Heat and drought tolerant, these long lasting plants that will provide generous colour all season. A perfect plant for the novice or experienced gardener because it is so undemanding with loads of blooms. The mature plants are mid-sized, about 30 to 35 cm (12 to 14 in) tall and wide.

**A675 Starlight Rose
 A679 Mixed
 A680 Sunburst**

Pkt. 25 seeds **A** \$4.70; 100 seeds **B** \$17.50; 500 seeds **C** \$54.95

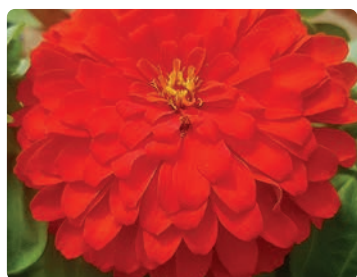

A665 Holi Scarlet
 These bright and unique blooms are quite a conversation starter! The blooms measure 5 cm (2 in) across and have a super-packed, semi-double form that holds up well in garden or vase. Ht 75 cm (30 in).

15 seeds **A** \$7.45; 50 seeds **B** \$21.95; 100 seeds **C** \$39.50



A610 Dwarf Zinnita Mix
 Mini Zinnias covered in masses of fully-double blooms in shades of orange, white, rose, scarlet, and yellow. Plants grow to 20 cm (8 in) high and wide, providing quick and easy colour. A top choice for beds, containers, or edging.

25 seeds **A** \$4.35; 100 seeds **B** \$15.10; 500 seeds **C** \$50.25

FEATURE ZINNIA



A650 Zowie! Yellow Flame
 We planted these in our front yard and could not believe the show! Each 8 to 10 cm (3 to 4 in) semi-double bloom contains a scarlet/rose center with yellow petal edges. The colour combination is uniformly intense, like a yellow flame. Great as a focal point in containers, but best in mass plantings for loads of cut flowers. Mature plants reach 72 cm (29 in) and spread 65 cm (27 in).

Pkt. 15 seeds **A** \$6.85; 50 seeds **B** \$23.40; 100 seeds **C** \$42.10; 500 seeds **D** \$137.50

Customer Favourite



A660 Up roar Rose
 Gorgeous colour with impeccable form! Talk about eye-catching! This neon-bright Zinnia will draw visitors to your garden, not to mention butterflies, to feast on its brilliant colour and heavy bloom. Flowers measure 10 cm (4 in) wide and more than an 2 cm (1 in) high, packed with zingy magenta-rose petals and sporting a merry little yellow crown at the center. 1 m (36 in) and 60 cm (2 ft) or more wide, with such strong branching that you get more buds than you'll believe possible. A must for any garden!

Pkt. 15 seeds **A** \$5.95; 50 seeds **B** \$21.95; 100 seeds **C** \$39.50; 500 seeds **D** \$132.00



A625 Green Envy
 No sunny summer flower garden is complete without the sure colour of tall garden zinnias. These bright and unique blooms compliment all colours. The blooms measure 5 cm (2 in) across and have a super-packed, semi-double form that holds up well in garden or vase. Ht 75 cm (30 in).

50 seeds **A** \$4.70; 250 seeds **B** \$10.95; 500 seeds **C** \$19.70

*Manitoba Residents: flower seed is taxable

GRASS (ORNAMENTAL)

DICHONDRA

COLEUS



B199 Pennisetum Fuzzy
Upright narrow 10-12cm/4-6 in dense pink/purple feathery heads atop fine green leaves. Great for rock gardens and for cut and dried arrangements! Ht: 60 cm (24 in).
Pkt. 25 seeds **A** \$4.75; 200 seeds **B** \$17.50



B189 Jade Princess Millet
Jade Princess is the latest in millets bred for ornamental qualities. It's a top-notch sun foliage plant with intense chartreuse leaves that contrasts nicely with the fragrant dark brown upright plumes. Ht 1-1.2 m (3-4 ft).
Pkt. 10 seeds **A** \$9.95; 25 seeds **B** \$16.75; 50 seeds **C** \$30.15



B190 Purple Majesty Millet
This purple-leafed millet can grow from 1-1.6 m (3-5 ft), with 20-30 cm (8 - 12 in) flower spikes. Great for flower arrangements or left on the plant to feed the birds. Easy to grow, tolerant of heat and low moisture.
Pkt. 10 seeds **A** \$8.95; 25 seeds **B** \$16.75; 50 seeds **C** \$30.15

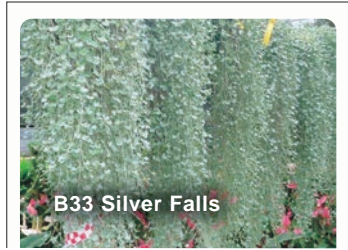

B33 Silver Falls
Use as groundcover Or trailing in pots!

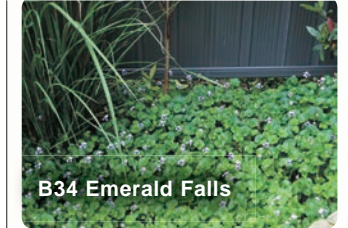

B34 Emerald Falls
These vigorous growing vines are "the" container plant, whether planted by itself or in mixed pots! **Silver Falls** has a Unique fan-shaped silver foliage cascading down providing an exotic tropical look to any container! The stems are even a silver colour! **Emerald Falls** is a more compact plant, very heavy branching, quickly covering containers. Gorgeous solid green coloring. Both are very heat and drought tolerant and will recover quickly even if wilted! **Also** great used as a ground cover or in rock gardens. **Pelleted seed.**

B33 Silver Falls
B34 Emerald Falls
Pkt. 10 seeds **A** \$5.95; 25 seeds **B** \$13.25; 50 seeds **C** \$23.85



B188 Bunny Tails Grass
Cute and fuzzy, just like its namesake. The attractive foliage bears fur-like, silky heads with grace and beauty. Ht is 45 cm (18 in).
Pkt. 50 seeds **A** \$5.25; 250 seeds **B** \$15.50



B120 Wizard Mix
A complete blend, from pastels, bi-colours to solids in endless variations. Compact habit and produce very large foliage.
Pkt. 50 seeds **A** 6.95; 500 seeds **B** \$59.95

ORNAMENTAL GRASS



Luminous Plumes

B205 Feathertop
Makes an elegant fresh or dried flower. Masses of white, woolly, 15 cm (6 in) plumes on graceful plants forming 30 cm (12 in) mounds. Showy accent in any landscape or bouquet!
Pkt. 10 seeds **A** \$7.95; 50 seeds **B** \$15.95; 100 seeds **C** \$24.95



B195 Frosted Explosion
These airy flower plumes will look like fibre optics in your garden! Add sparkle to your bouquets and landscapes. Keep trimmed for continuous blooms. Ht. 60-80 cm (24-32 in).
Pkt. 10 seeds **A** \$8.95; 50 seeds **B** \$16.95; 100 seeds **C** \$24.95

Sun Tolerant



B115 Chocolate Covered Cherries
Rose centers on each leaf are surrounded by deep mahogany, and topped off with thin green margins. Ideal for beds, baskets and containers. Ht/Spread 30 cm (12 in). Pelleted seed. Prices below



B124 Pineapple Surprise
Unique and versatile tricolour pattern-iridescent chartreuse and deep burgundy hearts are splashed with chartreuse and green. 45-66 cm (18-26 in) plants. Pelleted seed.
Pkt. 10 seeds **A** \$5.75; 25 seeds **B** \$13.25; 100 seeds **C** \$47.70

EUCALYPTUS



B119 Baby Blue
Repels Rabbits

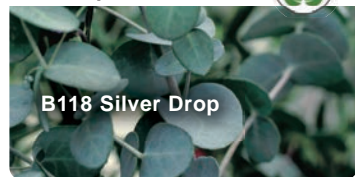

B118 Silver Drop
B119 Baby Blue
Unusual round leaves are pierced through the centre by the stems. Tolerant of neglect like the cactus, but much faster growth. Excellent as a pot plant and for dry-flower arrangements. Your choice of colour! Ht is 40 cm (16 in).
Pkt. 25 seeds **A** \$4.75; 100 seeds **B** \$17.75

*Manitoba customers: flower seed is taxable

CLIMBERS AND VINES



FEATURE VINE

A410 Nasturtium Out of Africa (Variegated)
An absolute must in your garden, in pots on your deck or patio or just allowing them to trail over a rock wall! Wonderful flowers of yellow, red, cream and peach-pink contrast nicely against the mottled variegated foliage. Useful for tumbling over walls and planters! Equally stunning when used in a mass planting or a ground cover!

5 grams **A** \$4.35;
25 grams **B** \$9.95



A344 Spanish Flag Firecracker Vine

This unusual annual vine has up to 12 beautiful tubular flowers on each spike. It's easy to grow, and excellent on a trellis, fence or in a hanging basket. Also makes a great cut flower. Climbs to a height of 5 m (15 ft) and quickly provides a dense leafy cover over any suitable supporting structure.

50 seeds **A** \$4.15; 250 seeds **B** \$14.95



Cobaea (Cathedral Bells)

One of the fastest growing annual vines available. Exotic, large cup-shaped flowers bloom throughout the summer and into fall. Alba has a white flower that are greenish on opening, later turning into a creamy white. Ht 3 m (10 ft).

A350 Cobaea Alba (White)

Pkt. 20 seeds **A** \$4.70;
Pkt. 100 seeds **B** \$12.35



A370 Nasturtium Canary Bird Vine

Bright canary yellow flowers which resemble a canary bird in flight, with attractive foliage make this a great backdrop. A rapid growing vine that will quickly cover your trellis, fence or arbor. Ht 3 m (10 ft).

Pkt. **A** \$4.15; 10 grams **B** \$9.95



Fern-Like Foliage

A345 Morning Glory Cardinal Climber

A very quick growing vine. It has a beautiful fern-like foliage with showy 5 cm (2 in) red trumpet shaped flowers. Ideal for covering fences, chimneys and trellises.

Pkt. **A** \$4.15; 10 grams **B** \$10.50



A346 Morning Glory Heavenly Blue

Large pastel-blue flowers contrast with the rich green leaves. Likes a warm cozy spot. For early bloom, start indoors in peat pots. Ht 3 m (10 ft).

Pkt. **A** \$4.15; 10 grams **B** \$9.95



A343 Morning Glory Scarlet O'Hara

Big blooms-a full 10 cm (4 in) across! Deeply deeply coloured and with a velvety texture that adds depth to their rich display. It's the one you want to quickly cover that ugly chain-link fence, or climb the patio trellis.

20 seeds **A** \$4.15; 100 seeds **B** \$9.95



A342 Morning Glory Grandpa Ott's

One of the original Bavarian varieties! Small, deep purple blooms, with a bright red star in their throats. Vigorous 15-foot vines. Perfect for covering walls, privacy screens and lattice.

Pkt. **A** \$4.15; 100 seeds **B** \$9.95



B85 Thunbergia Black Eyed Susan

Annual trailer, used for hanging baskets. Easily grown, will bloom early. Mix of popular colours, orange, yellow and white, all with black eyes.

Pkt. **A** \$4.35; 5 grams **B** \$10.50

NATURAL HEALTH PRODUCTS

5400 Aerobic Oxygen Oral Cleanse*



The formula of Aerobic Oxygen has not changed, it is the same product that has been sold for over 30 years. However it has been re-labeled as an "Oral Cleanse" so that it can be legally sold in Canada.

Directions: mix 10 drops in 3 tsp of water, rinse mouth thoroughly for 60 seconds. Repeat this procedure 2-3 times per day.

Bottle 60 ml (2 oz)
A \$24.95; 2 or more \$21.95 each

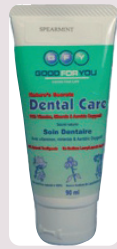

5425 Natural Spearmint Toothpaste*

Aerobic Oxygen toothpaste will increase the cleaning power of the toothpaste as well as oxygenate the gums to help maintain

good oral hygiene. The added Aerobic Oxygen in deionized water will help act as a natural preserver and as a Cellular energizer. Aerobic Oxygen will destroy all anaerobic bacteria and will complement the other ingredients added like Myrrh and Neem that act as a natural preservative and cleaner. Contains no fluoride.

90 ml tube A \$11.50; 2 or more \$10.50 each

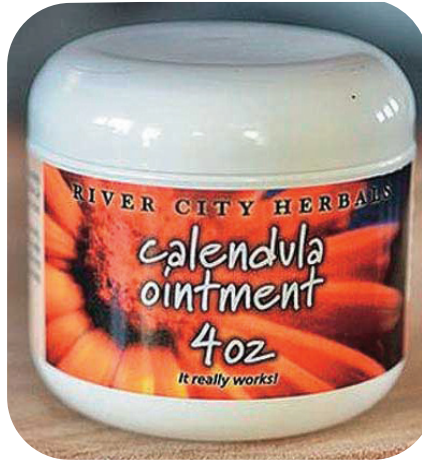

5130 Calendula Ointment*

Native to the Mediterranean, calendula is a highly versatile herb that has been used for centuries as a treatment for skin irritations and wounds. As an ointment, calendula has been shown to stimulate greater blood flow to the skin and to promote the granulation of tissue, making the skin more supple and resistant to physical and chemical irritants.

People have used calendula for skin irritations and fungal infections. Calendula has an aroma unlike any other flower that is instantly recognizable with a fragrance similar to that of tree sap or wood and is also sweet and musky. Try growing calendula in your garden this summer as a gorgeous, long lasting, self-seeding annual that bees will also love (page 44).

1 ounce jar A \$14.90 each; 4 ounce jar B \$39.10 each

PAMPER YOUR SKIN!

Natures way with bees aid.

These products contain beeswax, royal jelly (special food of the queen bee, beneficial effects on aging skin) or propolis (resinous substance collected by bees from tree buds, known for its healing properties). Made in Manitoba!



5122 Propolis Healing Cream*

Propolis has been known for years for its healing properties. Research has demonstrated its antibiotic, anti-fungal and anti-viral properties. Excellent for a wide range of skin problems. Unscented.

Jar 60 ml (2 oz) for A \$15.95; 2 or more \$13.95 each



5124 Royal Jelly Moisturizing Cream*

Royal Jelly is the special food of the Queen Bee. Among its many qualities is the beneficial effect it has on aging skin. Is enriched with a balanced mix of B vitamins, enzymes and amino acids. Unscented.

Jar 60 ml (2 oz) for A \$15.95; 2 or more \$13.95 each



5068 Bronkotux*

An expectorant which draws up and dissolves thick mucus, and is intended to soothe and relieve a whole array of upper respiratory symptoms, including coughs, bronchitis, sinusitis, colds, dry or sore throats and respiratory or pulmonary infections and irritations. Among its ingredients is Umcka (also known as South African Geranium), a herbal remedy which studies have shown to reduce the length and severity of colds and bronchitis.

200 ml A \$30.50
2 or more \$27.50 each



5035 Alterra Actifungi Cream*

Alterra's Actifungi copper cream treats a wide variety of problematic skin conditions. Alterra's copper cream uses powerful healing plants like German chamomile, geranium, myrrh and cedar to treat a variety of topical skin, hand, foot and nail bed conditions. Chamomile is a well known antifungal plant that is easily grown in any garden.

100 grams A \$36.95; 2 or more \$33.95 each

CLEAR YOUR HEAD!



5021 Gotu Kola*

Gotu kola is a perennial plant native to India and the South Pacific. A member of the parsley family, it has no taste or smell. It thrives in and around water. It has small fan-shaped green leaves with white or light purple-to-pink flowers, and small oval fruit. The leaves and stems of the gotu kola plant are used in traditional Chinese and Ayurvedic medicine to support memory and intellect, reduce mental exhaustion and brain fog. This formula contains no corn, nuts, gluten or soy and is vegan. 90 Capsules.

Each A \$32.95; 2 or more \$28.95 each



5095 Cool Mist Herbal Pain Relief Spray*

Muscle and joint problems are a frequent source of discomfort and pain especially for people with diabetes. Specially developed to provide relief to all muscle & joint problems including back, shoulder, neck and knee pain. Relieves sore muscle pain brought on by over-exertion or a minor sports injury. Contains menthol 3% eucalyptus oil 0.5% clove oil 0.2%

115 ml A \$17.50; 250 ml B \$25.95

*Manitoba residents: This page is taxable

STARTER TRAYS

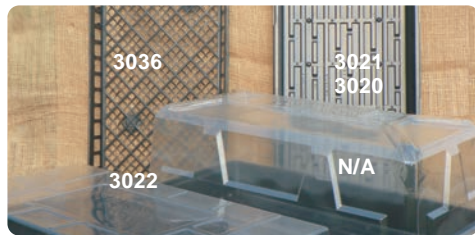

3020 Trays With Holes

3021 Trays Without Holes*

Standard plastic trays for home use (1020 type). All flats and inserts fit into these. Trays approximately 29 cm x 54 cm x 6 cm deep (11 1/2 in x 21 1/4 in x 2 1/2 in deep).

3036 Tough Trays*

Heavy-duty carrying tray for above trays made of plastic with lattice sides and bottom. Gives extra support for handling heavy transplants.

Prices for above trays

2 for **A** \$10.75; 6 for **C** \$31.00; 8 for **D** \$37.90; 25 for **H** \$102.75; 50 for **R** \$155.95

LIDS

3022 Shallow Plastic Dome*

Fits trays shown above. Improves germination because seeds are kept moist. Best dome for starting seeds under lights; seedlings remain closer to lights for stockier growth.

2 for **A** \$18.35; 6 for **C** \$39.50; 8 for **D** \$54.95; 25 for **H** \$155.00

HEAT MAT



3002 Heat Mat*

Many varieties of seeds will get off to a quicker start with bottom heat. Remember this: soil temperature is about 5 degrees below room air temperature because of evaporation. To achieve optimum temperature for starting most seeds, you require extra heat, which this mat provides. It will raise the soil temperature 5-10 C above room temperature. Works well as a pet warmer too!

Regular mat 25 x 50 cm (10 in x 20 in) **A** \$25.50; Larger mat 50 x 50 cm (20 in x 20 in) **B** \$49.50;

TRANSPLANTING INSERTS

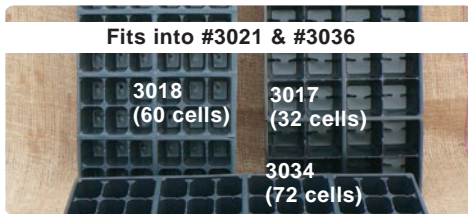

Fits into #3021 & #3036

3017 Geranium & Cutting - 804*

32 cells a tray. Each pot 6 cm or (2 1/2 in) square.

3018 Tomato & Pepper - 1006*

60 cells a tray, pots 4 cm by 4.5 cm (1 1/2 in x 2 in).

3019 Impatien & Petunia - 806*

48 cells a tray, pots 5 cm by 5 cm (2 in x 2 in).

3034 Bedding Pak - 809*

72 cells per tray, each pot 4 cm by 4 cm (1.5 in 1.5 in).

2 one type **A** \$8.35; 6 one type **C** \$20.65; 8 one type **D** \$24.10; 25 one type **H** \$69.95; 100 (1 case) **R** \$186.95

Fits into #3021 & #3036



3122 (32 pots) 3123 (18 pots)

3122 Square Pots 2 1/2" Inserts*

7 cm (2 1/2 in) square, 32 pots per sheet. Prices below.

3123 Square Pots 3 1/2" Inserts*

9 cm (3 1/2 in) square, 18 pots per sheet. 2 sheets **A** \$12.60; 4 for **B** \$20.25; 6 for **C** \$29.85; 25 for **H** \$102.50; 50 (1 case) for **R** \$170.00

SEEDING FLAT



3035 20-Row Seed Flat*

Start your seeds in rows, then transplant seedlings into either plastic or peat pots. Durable and sturdy, with drainage holes. Fits into #3021 (shown on this page).

2 for **A** \$18.35; 4 for **B** \$31.00; 6 for **C** \$45.95; 25 for **H** \$148.50

3038 Germination Tray no holes*

(11 1/2 in x 21 1/4 in x 1.2 in deep). Excellent 1/2 tray that holds 3035 seed starting tray, etc. No holes.

2 for **A** \$16.95; 4 for **B** \$27.95; 6 for **C** \$39.95; 25 for **H** \$137.95

TRANSPLANTING INSERTS



3004 T&T Starter Kit*

Kit includes 1 plastic tray; 1 clear plastic cover; 1 insert, pre-filled with 50 "New" Jiffy-7 Organics; 3 pot stakes for labeling. Can be re-used over and over. Each kit **A** \$21.25; 2 or more \$18.50 ea

3005 Jiffy 7 Organic Pellet Pak

Replacement tray for the Seed Starter Kit. Contains 50 Jiffy 7 Organics loaded in a plastic insert. Each **A** \$16.05; 2 for **B** \$26.40; 4 for **C** \$47.10; 6 for **D** \$66.65; 12 (1 case) **R** \$117.50

FIBRE POTS



Peat pots are especially useful for starting vine-type plants such as melons, morning glory, sweet peas, etc.

3010 Square Jiffy Pots 3"*

8 cm (3 in) square pots. 25 for **A** \$10.30; 50 for **J** \$19.50; 100 **K** \$34.45; 500 for **M** \$121.00; 1260 (1 case) **R** \$236.00

3011 Jiffy Strips (Square) 2 1/4"*

12 pots per strip (2 1/4 strips fit 1020 tray). 6 cm (2 1/4 in) square. Prices same as 3012 below;

3012 Jiffy Strips (Square) 3"*

6 pots per strip (3 strips 1020 tray). 8 cm (3 in) square. 2 strips **A** \$4.55; 6 strips **C** \$12.60; 12 strips **E** \$21.80; 24 strips **G** \$40.20; 100 strips **K** \$116.50; 210 strips (1 case) **R** \$236.00

3015 Round Jiffy Pots 4"*

10 cm (4 in) round pots. 25 for **A** \$13.75; 50 for **J** \$25.25; 100 for **K** \$45.95; 500 for **M** \$170.00; 960 (1 case) **R** \$291.50

3014 Jiffy Poly Pak-220*

Jiffy Poly Pak lets you handle 50 Jiffy-pots as easy as one. Each pot is 2 in square and 3 in deep. Fits 1020 trays. 2 trays for **A** \$18.35; 4 for **B** \$33.30; 6 for **C** \$47.10; 12 for **E** \$79.95; 40 for (1 case) **R** \$230.00

*Manitoba customers, all items this page are taxable.

PLANTING AID



3637 Planting Dibbler*

Anatomically designed, allowing you to make perfect holes in your planting medium. Brightly coloured plastic ensures they are highly visible in your work area.

Each **A** \$10.50;
2 or more \$9.50 each

LABELS



Customer Favourite!

Made of pressure-treated wood. More durable than plastic.

3642 For Flats*

15 cm x 2 cm (6"x5/8").
25 for **A** \$5.70; 50 for **J** \$10.30;
100 for **K** \$18.35; 500 for **M** \$69.95

3645 For Veggies*

25 cm x 2 cm (10"x7/8").
10 for **A** \$6.85; 25 for **H** \$12.60;
50 for **J** \$25.25; 100 for **K** \$44.25

3639 Nursery Marking Pen*

Best fine-line felt marking pen. Dries instantly, sun proof and waterproof. Non-smearing ink.

Each **A** \$4.95; 2 or more \$4.50 ea



Made of pressure-treated wood. More durable than plastic.

3647 Field Stakes*

38 cm x 2.9 cm (15"x1 1/8").
10 for **A** \$17.95; 25 for **H** \$34.95;
50 for **J** \$60.95



3649 12 cm (5 in) Plastic Labels*

Handy white plastic labels. Ideal for labeling all your flats or pots in the greenhouse. Thin, but strong enough to push into various soil mediums.

100 for **A** \$14.90; 500 for **M** \$51.70;
1000 for **R** \$84.95

PROFESSIONAL SOIL MIXES



Ideal Mix For Expensive Seed!

Rough guide: approximately 4 litres fill a planting tray #3021.

3200 T&T Blended Starter Mix*

Top grade fine-particle soilless mix for starting all seeds. Tiny roots develop quickly and easily. Pure, sterile. **8 litre bag.**

3205 T&T Professional Mix*

The same as professional growing medium used in commercial greenhouses. For transplanting, container growing and cuttings. **8 litre bag.**

Each bag your choice of above mixes **A** \$9.95;
2 bags or more your choice \$8.95 each

COIR BRIX

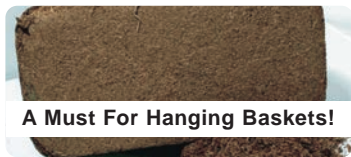

A Must For Hanging Baskets!

3247 Coir Gro Brix

Advanced organic growing medium made of pulverized coconut fibre which holds moisture better than peat moss and is sustainable. Add to soil mixes. Ideal for hanging baskets. Each brick makes 8 litres of soil.

Each **A** 5.95; 2 or more \$5.50 each

STARTER AIDS



New Gel Formula!

3366 Stimroot*

Dip your cuttings into this rooting hormone gel for rapid root development. Choose your strength!
25 gram gel bottle **A** (softwood) \$10.50; 25 gram gel bottle **B** (semi-hardwood) \$10.50; 25 gram gel bottle **C** (hard-wood) \$10.50

STARTING PELLETS



It's All About The Roots!

3009 Jiffy 7 Organic*

New Container and media in one! Add water to these pellets and they expand to form a plug of sterilized peat soil. Just plant a seed into the expanded plug and water normally. Each plug is 42 x 43 mm.

25 for **A** \$5.50; 50 for **J** \$9.50;
100 for **K** \$15.50; 500 (1 case) **R** \$71.50

T&T SUPER PLUGS



Grow perfect seedlings every time!

Minimize root-shock during transplanting and your plants will be off to a quicker, better start in their permanent location. Made of composted bark mulch and peat moss held together with a polymer, making it sponge-like, so root ball won't crumble when transplanting. Simply put a seed or cutting into the top and grow like normal. Particularly good for climbers, Melons, sweet Peas and other plants that hate root-disturbance.

3040 T&T Super Plugs Kit*

Kit consists of 12 plugs and 10 cm x 25 cm (4 in x 10 in) plastic insert.

Each kit **A** \$10.50;
2 or more kits \$9.95 each



3042 Replacement T&T Super-Plugs*

Replacement polymer plugs in bulk, very economical!
25 for **A** \$13.95; 50 for **J** \$25.95;
100 for **K** \$45.95



Fits Into #3021

3024 Jiffy 7 Preform Plug Trays 105's*

Similar to our Organic Jiffy 7's except in a "smaller" convenient plug size! Increased fine root development and "no disturb" transplanting. Each plug is 23 x 45 mm (a little bigger than a toonie) and there are 105 plugs pre-loaded in a plastic insert. (Tray fits into #3021 tray).

1 for **A** \$16.95; 2 for **B** \$29.95;
4 for **C** \$54.95; 6 for **F** \$79.95

PLUG TRAY



Compact design allows you to fit more plants in the greenhouse. Great for Seed starting, propagation, and hydroponics

3008 72 Cell Plug Trays*

Cells measure 4x4x5.7 cm (1.5x1.5x2.25 in deep) plugs consist of 70% coconut coir and 30% sphagnum peat moss, ideal seed starting medium. **(Fit into #3021 & #3036).**

Each **A** \$22.95; 2 for **B** \$42.95;
4 for **C** \$79.95; 6 for **D** \$114.95

SEEDING TOOLS



3650 Seed Master*

Now you can sow even the smallest seeds precisely and easily. Place seed in broad part of trowel, tilt dispenser unit slightly forward. Use thumb to lightly rotate wheel and the vibrations drop seed off edge, right where you want them.
Each **A** \$12.95



3660 Seed Sower*

Ideal for small and hard to handle seed. Saves time seeding and thinning. Instantly adjustable for all sizes of seed.
Each **A** \$4.95

*Manitoba customers; these items taxable.

Boost Everything you grow!

Fertilizer guru Peter Small tells you how best to boost-up everything you grow. (Every fertilizer contains a free scoop. One scoop = 30 gms or 30 ml or 2 tablespoons).



Boost all transplants and blooms!

3256 Rose & Strawberry (10-52-17)

- Great for all seedlings and for transplanting.
- Apply every 10 days to boost blooms and increase crop size. An excellent year round food for all your growing needs.
- Will enhance root systems leading to more vigorous growth in your containers, shrubs, fruit, annuals and perennials.

227 gram **A** \$13.95;
2 kilos **B** \$49.50;
11 kilo bag **C** \$214.95

For All Containers Add Directly To Soil



3263 Slow Release (14-14-14)

Peter says: Mix this into the soil when planting. Slowly releases nutrients all season. A must for all containers.

454 gram **A** \$17.50; 2 kilos **B** \$44.95; 11 kilo bag **C** \$84.94

For Acid-Lovers



3265 Blueberry (5-8-5, High Acid)

Peter says: Apply a teaspoon around acid-loving plants twice during the season (lilies, lupines, blueberries). Remedies yellowing leaves. **Ideal food for birch trees!**

227 gram **A** \$13.95;
454 grams **B** \$18.50

The Seaweed



Organic Seaweed

Will boost up the quality of all your plants and will make other fertilizers work better. Contains natural growth boosters, amino acids and loaded with micro-nutrients. Boosts up blooms, crop yield, taste, disease and insect resistance and germination rate. Makes plants more drought and frost tolerant. It's that effective!

3249 Pre-Mixed Liquid Seaweed Concentrate
500 ml of concentrate makes 37 litres or 8 gallons of fertilizer.

500 ml bottle **A** \$16.95; 1 litre bottle **B** \$26.95; 4 litre bottle **C** \$89.50

3250 Dry Seaweed

30 gram package will make 20 litres of concentrate, which in turn will make 300 litres of usable fertilizer. Easy-to-mix.

30 gr (1 oz) pkt. **A** \$12.95; 250 gr (8 ozs) **B** \$45.50

Boost Tomato Crops



3255 Tomato Ripener (11-0-44)

Peter says: Apply when transplanting, then every 10 days when flowers appear.

227 gram **A** \$12.95; 2 kilos **B** \$45.50

Boost Fruit/Berries/Trees



3260 Peter's Plumper-Upper (15-15-30)

Peter says: As soon as fruit appears water in every 10 days. Also an excellent tree and shrub fertilizer, apply 3 to 4 times a season!

454 gram **A** \$16.95; 2 kilos **B** \$45.50



3253 Peter's All-Purpose (20-20-20)

Peter says: When everything is doing well, use this to maintain color and health. Apply twice during the season.

454 gram **A** \$15.95; 2 kilos **B** \$45.50;

The Wetting Agent



3290 T&T Wetting Agent

This organic formula makes water molecules more absorbant! Hence making your fertilizers easily and fully available to plants. It works!

500ml (18 oz) **A** \$22.95

Boost Corn/Cukes/Melons



3258 Corn Fertilizer (25-0-0 + Sulphur)

Peter says: When Corn is 15 cm (6 in), water with this every two weeks for the plumpest, best-tasting corn. Good for cucumbers and melons too.

227 gram **A** \$13.95; 2 kilos **B** \$49.50

Boost Transplants



3309 Evolve Root Booster (5-15-5)

Transplant fertilizer suitable for all bedding plants, seedlings, transplants, vegetables, shrubs, indoor and outdoor plants. Evolve Ultra Transplanter contains two hormones: indole-3-butyric acid and Naphthalene Acetic acid to enhance the performance of your plants. Reduces transplant shock.

1 kg bottle **A** \$21.95;
2 or more \$19.50 each

Our sprayer makes it easier than ever!

5 minutes to a lush garden!



Pour 3 scoops of any fertilizer on this page into sprayer.



Add 6 scoops liquid seaweed. Fill with water to top line and stir.



Add 1 scoop of wetting agent, stir again, spray till empty. You've fertilized!

3295 Sprayer

This is the best sprayer we've seen anywhere. You can even reach the tops of trees! Have one for fertilizers and one for herbicides/pesticides. (Pictured above).

Each **A** \$18.50;
2 or more \$17.50 each

How to mix and use our fertilizers in a standard watering can (2 gal).

- 1 scoop fertilizer
- 2 scoops liquid seaweed
- tiny squirt wetting agent
- fill to top with water
- apply every 2 to 3 weeks

NATURAL SOLUTIONS & FERTILIZERS

Worm castings to "boost" your plants!

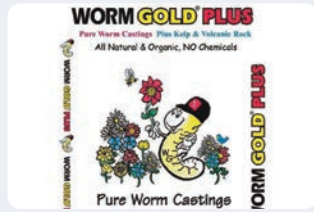

3210 Wormgold

Want your seeds and seedlings to explode with exceptional growth? That's what worm castings have been shown to do in recent exciting research in California, just by working in a 3 cm (1 inch) layer of worm castings around the plant. The plants absorb an enzyme called chitinase from the castings. This is an enzyme which is believed to aid in repelling harmful insects.

- Sprinkle 1 cm (1/4 in.) around the plant every six months.
- Worm castings are the rich earthy-smelling waste matter of worms.
- Now available to gardeners in this dry granular form.
- Contains lots of nutrients making it a perfect additive for soilless and potting mixes.
- Helps balance your soil.
- Enhanced with kelp and volcanic rock (this further enhances biological activity in the plants for even stronger growth)!

2 kilo bag **A** \$12.95; 5 kilo bag **B** \$21.95 250 gram bag **E** \$5.95

**New smaller pack size
Great for houseplants too!**



3689 Jute Twine*

For fastening applications around the home & garden. Center pull for knot-free dispensing. Natural jute material. 150m (495 ft).

Each **A** \$7.95; 2 or more \$6.95 each



3274 Clay Buster*

Has 21% calcium and 16% sulphur that will penetrate heavy clay soil and break up particles, allowing roots of plants to seek out rich nutrients that are usually abundant in such soils. One bag covers about a 1000 sq ft.

Bag 5 kilos **A** \$21.50; 2 or more \$19.50 each



3270 Turkey Trot (6-4-6)*

One of the best organic fertilizers you can use. It consists of composted deodorized granular turkey manure. Compared to commonly available inorganic fertilizers which only benefit plants, Turkey Trot will build up your soil, making it better each year, providing vital micro-nutrients to everything you grow. Use sparingly, approximately 2 pounds per 100 sq ft. Use everywhere, lawns, vegetable and flower beds, when planting bulbs, etc.

Each 5 kilo bag **A** \$23.50; 10 kilo bag **B** \$44.95 each



3252 Garden Sulphur*

Add to soil to acidify - ideal for fruit trees. Dust on leaves of plants to help with Powdery Mildew, Rust, Black Spot, Scab and Mites in the garden. Will improve the efficiency of nitrogen used by plants and ideal as a bulb dust for storage.

500 gr (1 lb) shaker (powder) **A** \$15.95; 1 kilo refill (powder) **B** \$32.95; 5 kilo (granular form) **C** \$34.95



3380 End All*

Contact control gets Aphids, Mites, Thrips, Spittle bugs, Flea Beetles, Caterpillars, Mealybugs, Scale insects and Whiteflies at all stages--eggs, nymph and the adult stage. So safe, that it can be used right up to the day of harvest of fruit and vegetable crops! Use on everything. Contains canola oil and pyrethrins--derived from Chrysanthemum roots.

1 litre RTU sprayer **A** \$16.50; 500 ml concentrate **B** \$21.50; 4 litre conc. **C** \$148.50



3375 Safer's Organic Slug & Snail Pellets*

Safer's - NEW! Contains a more effective formula which increases palatability and is quick acting. Sodium Hydroxy EDTA is faster acting; feeding stops immediately after the bait is eaten! Uses 1/2 of the amount of active ingredient by weight and can be applied at 2/3 the rate of our old formula delivering even better results. Waterproof plastic shaker box.

1 kilo box **B** \$23.50

Does not contain metaldehyde and can be used safely around pets, birds and wildlife.



Warmth & Bug Prevention

Hoops now available

3540 Classic Garden Blanket*

This blankets unique qualities let light and moisture in while retaining heat. Seeds will germinate better and transplants get off to a better start. An alternative to toxic chemicals for insect control. Help deter Cabbage Fly from your cabbage, cauliflower and broccoli plants. Flowers and vegetables mature earlier and produce higher yields, and the fine fibre does not allow pesky insects in. Ideal in spring or fall to protect plants from light frost.

Roll size 67 in x 20 ft **A** \$23.50; 67 in x 50 ft **B** \$45.50; 67 in x 200 ft **C** \$160.00

3542 Landscape Staples*

Handy metal staples for keeping garden blankets in place. 15 cm (6 in) staples, Reusable. Ideal for all weed barriers!

20 pack **A** \$6.50; 50 pack **B** \$17.50

3590 Hoop Wires*

Pre-cut 6 ft lengths of heavy 9 gauge galvanized wire will support our Garden Blanket perfectly. Will make a 30 inch wide by 24 inches tall support arch, space them approximately every 4 feet along the blanket length.

Pkt. 4 wires **A** \$14.50; Pkt. 10 wires **B** \$32.95

STICKY TRAPSIZERS



3370 Sticky Sticks Houseplant Traps*

Fungus gnats and other insects buzzing around your houseplants? Just poke sticky yellow "leaves" into pots. Insects fly to the yellow colour and become stuck.

Pack (12 sticks, 24 'sticky' leaves) **A** \$12.95; 2 or more \$12.50 each

Revitalize your soil with Alfalfa Gold



3272 Alfalfa Gold*

This amazing new soil revitalizing mixture that conditions and improves the soil by adding back organic material and activating soil nutrients already present! **Customers rave about the results!**

- Specially formulated blend of alfalfa, humic acid, worm gold plus and bone meal.
- All 4 ingredients work together giving an all round boost to your growing medium.
- Ideal for flowers and vegetables, fruit, containers of all types, shrubs and trees.
- Easy to apply granular form, just mix in with soil and water in.
- Application rate, 2 lbs (1 kilo) per 25 sq ft of garden.

2 kilos **A** \$32.95; 5 kilo bag **B** \$39.95

Organic from the Sea!



3230 Fish Agra (4-1-1)*

Made from hydrolyzed whole fish. The hydrolyzation process is a low-temperature natural process in which enzymatic digestion breaks down the fish into simpler protein complexes and which protects and maintains the nutrients in the fish.

- Fish Agra® process uses whole ocean fish, not scraps.
- It has been trialed successfully on over 30 different crops including most vegetables, fruits, berries, and field crops.
- Use both as a foliar feed and at planting on the seed.
- Deodorized!
- Very effective in treating plants under stress.
- 46% solids & 100% organic!

1 Litre **A** \$31.50; 4 Litre **B** \$79.95

Organic Growth Enhancer



3235 Gro Spurt*

GS4 is a potent, water soluble, effective and efficient growth enhancer formulation that will stimulate both the cell division and cell elongation in leaves and stems, which enhances fruit set, fruit development and yield. Applying Gro Spurt on seeds helps to break dormancy, promotes seed germination under cold weather and soil conditions. Use at rate of

1 capful into 4L of water. The active ingredient is GA3 (Gibberellic Acid) which is one of the most widely used certified organic agricultural products in the world for nearly 50 years.

Specifically formulated for:

- Vegetables, fruits and flowers.
- Tomato fruit set and increase size and yield of tomatoes.
- Bedding plants, annual and perennial potted crops.
- Ornamentals and bulbs, grass and turf.
- Breaking seed dormancy to ensure seeds germinate quickly.
- And much more!

100 ml Concentrate **A** \$38.95; 2 or more \$33.95; 1 Litre concentrate **B** \$165.00



100% All Natural Fertilizer*

Slow release of nutrients will feed plants for the entire growing season. Won't burn plants like chemical fertilizers. Pellets hold up to 3X their weight in water, conserving soil moisture and protecting against over-watering by wicking away the excess. Wool increases soil porosity due to its natural expansion which aids root development and aeration. Deters slugs. A simple, natural, CANADIAN PRODUCT (ALBERTA).

3377 Sheep Wool Pellets*

1 litre **A** \$25.50; 2 litres **B** \$45.50



Amazing water and nutrient retention!



With



Without

For gardens: add 125 grams to a 16 metre row - 1 to 4 kilos per seeded acre - 1 kilo per yard of soil

3310 Stockosorb Medium*

This is a new advanced hydrogel technology that is a water and soil management tool designed for the horticultural industry. This amazing product holds hundreds of times its weight in water. Easy to apply - just mix in soil at time of planting!

- Optimizes moisture conditions for maximum plant growth. Reduces frequency of watering.
- Developed specifically for water and nutrient retention in soil and potting mixes.
- Enhances survival rates of new plants, shrubs and trees.
- Effective for more than 1 season and will hydrate and de-hydrate dozens of times over the growing season.

500 Grams **A** \$19.95; 2 kilo bag **B** \$52.95; 5 kilo bag **C** \$124.95; 20 kilo bag **D** \$396.00



3248 Kelp Meal

SeaLife Kelp Meal contains over 60 Micro-nutrients, trace minerals and an assortment of amino acids, enzymes, and alginates that feed and stimulate the necessary microorganisms in your soil.

500 g **A** \$9.95; 1 kg **B** \$16.95



EW10 Myke Tree & Shrub

An all-natural product that effectively harnesses the forces of nature. It delivers superior growing results, expands the life span of trees and shrubs, and accelerates recovery from transplant shock.

1.5 L **A** \$24.95; 4 L **B** \$54.95

SOIL CONDITIONERS

POTS & AIDS



3391 MX3 Fulvic Acid*

MX-3 is a unique blend of Fulvic Acid designed to maximize nutrient availability, uptake, and translocation. Thus improving the health of your plants and the nutritional value of the harvest. Additional benefits are improved root development and robust new growth when applied either foliar or with feeding as directed. Will boost crop resilience against environmental stresses such as heat and drought. Additional vital benefits include:

- Enhanced crop resistance against insect pest pressure and disease such as PM (Powdery Mildew).
- PH buffering to allow for better nutrient availability to plants.
- Substantial Increase in soil micro pores providing better aeration for roots and support for soil biology.
- Allows for reductions in water requirements.
- Safe in all grow systems and mediums.
- Completely effective at all nutrient pH ranges (5.4 - 6.5).
- Very concentrated, mix 10 ml per litre of water and foliar feed plants. Apply 2 to 3 times a season.

Each 100 ml bottle **A** \$12.50; 450 ml **B** \$36.95 each; 4 Litre **C** \$100.50

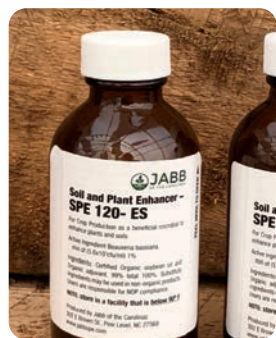

3275 SPE-120-ES Soil & Plant Enhancer*

SPE-120 soil and plant enhancer with active ingredient beauveria bassiana, is a natural, symbiotic fungus that lives in the soil, roots, stems, and leaves. SPE-120 will grow with the plant! Conventional seed treatments using neonicotinoids or other synthetic chemicals have a finite amount that can fit on the seed. They become less effective as the plant grows and are not compatible with nature. SPE-120 blends food grade and certified organic products with beauveria bassiana. Certified organic. Can be

applied at seeding time or sprayed on plants during growing season. Highly concentrated, 25 ml per 4 litres, will treat 1,000 square feet of garden. Can use on all vegetables, flowers, lawns, shrubs and trees.

Each 100 ml **A** \$12.50; 250 ml **B** \$26.95

Will aid your plants and crops in many ways:

- Stimulation of immune system.
- Restricts plant pathogens from entering the plant.
- Interacts with plant to produce additive biochemicals.
- Combines plant resistance to insect feeders for reducing population threat.
- Will enhance flavour in all your vegetables.

*Manitoba residents: these items taxable



3891 Potato Pot*

A unique 2-piece plastic container for growing potatoes, sweet potatoes, carrots, and other vegetables! Made of thickening pp material: durable and anti-aging, can be used many times. Easy to pull out the inner pot to see if the vegetables are ready for harvest! Just lift inner pot to quickly view progress of potatoes and other root crops! Enjoy potatoes earlier and all season long.

Each set **A** \$13.50; 2 or more \$11.50 each



3298 Spreader Jar*

This handy spreader makes it easier to tend to your outdoor chores. Simply fill this heavy duty container with grass seed, granular fertilizer, wormgold, clay buster, turkey trot, alfalfa gold and more, and spread it right where you want it. Constructed of durable plastic, this shaker container has an adjustable dial lid to help secure contents and provide quick coverage, and a large handle for comfort and ease of use. Measures 23 cm (9 in) in height, 1.5 litres volume. No more lugging heavy bags of ice melt or lawn and garden treatments around the yard! Perfect for gardeners and DIY'ers alike, this convenient spreader makes a great housewarming, birthday or holiday present.

Each Jar **A** \$14.50; 2 or more \$12.50 each

DIGITAL SOIL TESTER

3180 Digital Soil Tester*

Utilizing advanced LED digital technology and optical calibration systems, this test kit quickly and easily tests soil samples measuring levels of ph, nitrogen, phosphorus and potassium. Complete instructions, fertilization guidelines and pH preferences for over 450 plants.

Each **A** \$49.95



PROBLEM SOLVERS

Organic way to control pesky caterpillars



3372 Safer's BTK Biological Insecticide*
 Contains bacillus thuringiensis, a bacterium that kills all types of caterpillars including spruce budworm, cutworms, canker worms, forest tent caterpillars, cabbage worm (also the larvae of potato bugs &

lily beetles) by infecting their digestive systems. Just spray on leaves. As soon as they ingest it they stop feeding and die. Concentrated: makes 30 litres (7 gal) of spray.

Safe for animals and people!

100 ml bottle **A** \$16.95; 2 or more \$15.95 each



Stop problems before they start!

3320 Dormant Spray Kit*

Mix Wilson liquid lime sulphur insecticide (1 l) with liquid dormant oil spray (500 ml) to smother overwintering insect eggs and destroy fungus spores on your fruit trees, roses, shrubs and ornamentals. Oil helps lime sulphur stick to branches for total coverage. Apply in early spring when danger of frost is past, before leaf buds show green at tips. Kills insect eggs, oyster shell scale, rose scale and black scale. Prevents later problems. **A must for all fruit trees!**

Each kit **A** \$40.50



3354 Go Green Pyrethrin*

Effective when used to get rid of bed bugs, ants, cockroaches, silverfish, spiders, earwigs, sowbugs, crickets, certain beetles, box elder bugs, fleas. Derived from the chrysanthemum plant. This formulation is known to kill pests hiding or actively crawling in any part of your home or garden. Suitable for use both inside, and outside in the garden.

- Ready to use.
- 600 gram **A** \$26.50; 2 or more \$24.50 each.

Durable Plastic Netting Protection

Made of tough UV resistant black polypropylene netting! 1.5 cm (5/8 in) x 1.5 cm (5/8 in) mesh size on 3485 & 3487.



Deer-D-Fence*

Protects trees, shrubs and gardens from hungry deer and other pests.

Each roll
 2.1 m x 30.4 m
 (7 ft x 100 ft)

A \$55.50; 2 or more \$50.50 each



Bird-D-Fence*

Protects cherries, berries and other fruits and vegetables from hungry birds and animals. Great for keeping animals and debris out of ponds too!

Each roll 2.1 m x 6.4 m
 Regular (7 ft x 21 ft) **A** \$16.95;
 Large (7 ft x 100 ft) **B** \$59.95

Control pesky Birds!



3399 Birdscare Flash Tape*

Suspend this silver and red metalized plastic tape above your crops in a loose spiral and say good-bye to your bird trouble. The reflection off the tape is a brilliant and dazzling flash effect that signals danger to the birds. Customers have also

reported it deters deer and geese. Just tie to sticks placed around your yard, the movement and reflection scares them!

Each roll (290 ft) **A** \$13.50; 2 or more \$12.50 each

Garden Netting

SUPPORTS

- Peas
 - Beans
 - Cucumbers
 - Grapes
 - Tomatoes
 - Clematis
 - Nasturtiums
 - Vining Flowers
- and many more climbing plants...



3830 Garden Netting*

Plastic garden net acts as an excellent support system for climbing vegetables. Reduces disease and ground rot losses by keeping produce off the ground and providing better air circulation and light. Strong weatherproof support netting is 1.8 X 3.7 M (6 x 12 ft).

Each roll (6 x 12 ft) **A** \$11.50;
 2 or more \$10.50 each

Natural Animal Repellent!

3388 Critter Ridder*

Chemfree Critter Ridder is made from a unique formula containing natural mineral and vegetable ingredients. It works on small animals by perturbing their sinuses. This creates an unpleasant, yet harmless



reaction that conditions animals away from treated areas. Remains effective even in rainy conditions for up to 30 days. Use to deter dogs, cats, raccons, skunks, squirrels, mice, rats, deer, gophers, moles and other animals. **To discourage raiding of bird feeders by squirrels!**

940ml RTU Spray **A** \$30.75; 1 Kilo granular **B** \$30.75 2 or more (your choice) \$27.75 each

Tough on Ants!

3530 Ortho Ant B Gon Max*

Stop marching ants in their tracks with the NEW Ortho® Ant B Gon™ Max Ant Eliminator. Specially formulated to kill these small but mighty pests, this product comes in a convenient, ready-to-use spray bottle.

1 Litre RTU Spray **A** \$16.95



*Manitoba residents: these items taxable

CHASE DEER AWAY!

POND TREATMENT



3251 Iron Chelates*

Concentrated iron is used directly by plants to prevent chlorosis and also to give plants and lawn a rich, dark-green appearance. Iron is often tied up in the soil causing yellowing leaves. Spray on or water in, as soon as you see the tell-tale signs.

227 gram **A** \$19.95; 454 gram **B** \$34.95; 2 kilos **C** \$120.95



3383 Last Crawl Insect Destroyer*

Made from fresh water diatomaceous earth, Last Crawl kills household and garden insects without the addition of any chemical additives. It's perfectly safe for humans, animals, fish and food and can be used outdoors and indoors. Controls Earwigs, Ants, Cockroaches, Spiders, Beetles, Silverfish, Bedbugs, Crickets, Wasps, Fleas, Grain insects, Lily Beetles and Slugs. %100 Silicon Dioxide.

400 grams **A** \$19.50; 1.8 kilo **C** \$35.50



3353 Copper Spray*

This wettable powder fungicide helps control early and late tomato blight, septoria leaf spot on tomatoes, black spot on roses, anthracnose, fireblight and peach leaf curl. Spray on tomato plants as a preventive measure early in the season, especially if you had a previous blight problem.

250 gram jar **A** \$17.50; 500 gram jar **B** \$25.95



3545 Spray Away*

Protect your yard, garden or pond from animal trespassers with this motion activated sprinkler with an exclusive adjustable sensor eye. Adjusts to any size animal and any terrain.

- Using only water and noise, this eco-friendly and low-maintenance alternative to pesticides works 24/7 to deter even the most determined critters.
- Repels deer, racoons and other animals, keeping your landscape lush and beautiful.

Each **A** \$88.50; 2 or more \$76.95



Will not affect fish, plants, people or wildlife.

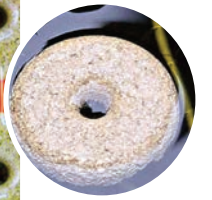

3347 Mosquito Dunks*

Place mosquito dunks in ponds or standing water and it's active ingredient, bacillus thuringiensis subspecies israelenses called BTI kills mosquito and black fly larvae for 30 days or more. While floating they slowly release a long term biological mosquito larvacide killing the larvae before they hatch into adults. Will not affect fish, plants, people or wildlife. Alternative wetting and drying will not reduce it's effectiveness. Use one dunk per 100 sqft of water surface. Perfect long term solution for pond gardeners! Will work on fungus gnats also!

6 'puck' pak **A** \$29.95; 20 'puck' pak **B** \$60.00; 2 'puck' pak **C** \$16.95



WE HAVE MORE ON OUR WEBSITE
TTSEEDS.COM

- ✓ MORE Variety
- ✓ MORE Accessories
- ✓ MORE Information

SEED STARTING KIT



3550 Burlap Seed Starter Kit*

Use for quicker and better germination of your seeds such as carrots, beets, lettuce and other types of seed. Small seeds don't always survive long enough in the garden to germinate. The hot sun can "cook" finer seed before it can germinate, birds may raid the bed right after you finish planting, or heavy rain may wash the seeds away. Covering the seeds with burlap protects them so they stay just where you planted them until they sprout. Burlap also retains moisture so the soil doesn't dry out, while allowing you to irrigate without fear of washing away the seeds. This kit comes with all you need to get your rows started and protected. **Note: seed not included.**

- 2 pieces of burlap sheets, 30 cm x 3 m (12 inches wide x 10 feet long).
- 20 Landscape Staples 30 cm x 3 cm (12 in x 1.18 in).
- Instructions included.

Each kit **A** \$14.95; 2 or more kits \$12.95 each

*Manitoba residents: these items taxable

MINI MICROSCOPE



Mini Microscope with LED Light*

Examine objects outdoors and indoors in great detail! 30X magnification universal phone microscope with LED lights that works for all types of mobile phones and tablets. You can take a photo or video and save it on your phone.

- It fits for all smartphone or tablet thickness between 0.5inch and the distance between the camera and edge under 0.9inch. (phone not included).
- Built in LED lights provide enough light under any low light conditions.
- LED powered by coin cell battery.
- Magnification: 30X
- Portable design
- Size: w6.35x3.17x3.17 cm (2.5x1.25x1.25 in)

3394 Mini Microscope with LED Light*

Each **A** \$17.50

BOBBEX DEER & RABBIT REPELLENT



Environmentally Friendly!



All natural, environmentally friendly easy to use. Will not burn plants and dries clear. What separates Bobbex from the rest is that it is protein based. Bobbex repels by smell and taste. It is an odour that lasts for a couple of hours to people but lingers to the deer. If a deer can get past the odour to take a bite they quickly move on because of the protein taste. One of the many features of Bobbex is that it won't wash off. Apply when dry let set for a couple hours, it can last for up to 28 days on established landscapes. In springtime or rapid growth periods application should be every 2 weeks. Another quality of the product design is it helps plants with winter burn and helps with heat and water loss in summer months

3352 Bobbex

950 ml RTU (33 oz) bottle **A** \$34.95; 950 ml Concentrate (33 oz) bottle makes 5 L - **B** \$55.95; 3.8 litre Conc. (134 oz) bottle makes 20 L - **C** \$176.00

GROWING AID



3182 Digital 3 Way Analyzer*

This Digital 3-Way Analyzer will provide you with the ability to quickly and easily test your soil - take the guesswork out of gardening!

- PH function reads the soil acidity/alkalinity.
- Temperature function finds when the soil is the proper temperature for planting.
- Fertility function reads the combined levels of nitrogen, phosphorus, and potash to determine the nutrient health of the soil.

Each **A** \$53.95

SOIL AMENDMENT



Rootlets cling to Dolomite Nutrient



Granular Dolomite

3335 SRMNutrient-D*

Use our slow-release Ca-Mg Nutrient. Soil nutrients are essential for food nutrients. Your plant production will benefit by using our SRMNutrient-D (custom-ground Dolomite). Ca-Mg Nutrient - (**lab analysis 31% Ca, 21% Mg**). Equally effective for greenhouse, home or market garden. Useful in all stages of growing, from seedling to field.

Each 500 grams **A** \$12.60; 2 kg **B** \$17.50 each; 5 kg **C** \$27.95 each

Manitoba residents: This page taxable

ULTIMATE PLANT WASH!

TEST YOUR SOIL!



3160 Plant Wash Plus*

Aids in damping off! A great all-purpose wash for greener and healthier plants! Just spray a fine mist on foliage and stems on all indoor or outdoor plants and watch your plants flourish. They will appreciate it! Also very good for aiding seedlings, will help in early stage health! Spray all plants once a month and for plants under stress spray at least once a week. Can be used on plants such as potatoes, tomatoes, cucumbers, grape vines to keep them healthy. Active ingredient .08% Akwaton, which is 99.99% effective against bacteria, fungi and spores.

1 Litre RTU spray bottle **A** \$17.50; 2 or more \$16.50 each.

TREE BANDING



3490 Sticky Foot Paste*

This tree paste is a non-drying, sticky compound that forms a barrier against insects. Including spring and fall Cankerworms (adults), Gypsy and Tussock Caterpillars, climbing Cutworms, Ants (control of Ants effectively reduces damage by certain Aphids, Mealy Bugs and some Scale insects).

227 gr Jar **A** \$15.95; 425 gr Jar **B** \$21.95



3492 Tree Wrap Banding*

Used with Stickyfoot tree paste. A tough tree band for rough barked trees. Insulate bonded to heavy aluminum stops insects from crawling up trees. Wrap the trees in the fall or first thing in the spring and coat with Sticky Foot paste. Can be easily removed once the leaves appear in the spring. Roll 3 inch wide x 20 foot long.

Roll **A** \$15.95; 2 or more \$12.95 each

VELCRO TAPE



3279 Velcro Garden Tape*

What a great idea! Cut off a few inches of this 1/2 inch, double-sided, green velcro tape to strap your tomatoes, cucumbers and climbing roses to their supports or stakes. Adjustable and reusable. Roll is 9.1 m x 1.2 cm (50 ft x 1/2 in wide).

Roll **A** \$9.95; 2 or more \$8.95 each.



3185 Rapitest Soil Kit*

Stop guessing about the fertility and pH of your soil. This kit makes testing remarkably easy. A pinch of soil, a little water, break open a powder capsule and compare the colour with a chart. In seconds you know what your soil needs. You can test nitrogen, phosphorous, potassium and pH 10 times each for a total of 40 tests. Includes pH preference chart for 450 plants.

Each kit **A** \$27.50



3630 Mini 4 in 1 Tester*

One tester to help you provide a healthy growing environment by determining: Soil alkalinity/Acidity; Soil fertility; Soil moisture; Sunlight. Quick and easy to read.

Each **A** \$22.95

SOIL THERMOMETER



3627 Digital Soil Thermometer*

Be sure your soil is warm enough to plant! This handy digital thermometer allows you to quickly measure your soil's temperature. Simply turn it on, push the probe into the soil, and read the temperature. Large digital display makes for easy reading. Batteries included.

Each **A** \$24.95

Handy Clips



3387 Tomato Clips *

Saves both time and labour compared with other trellising methods. Quick-release feature allows gardeners to move clips during the year or save them for multiple seasons. White plastic clips allow for a 3/4-inch diameter stem. Perfect for tomatoes, cucumbers and other vine crops.

Pkt. 25	A	\$5.50
Pkt. 50	B	\$9.50
Pkt. 100	C	\$17.50
Pkt. 500	D	\$46.50

Vinyl Tie



3688 Vinyl Stretch Tie*

Great for training and supporting your plants. Useful in the yard and garden. Expands with the growth of your plant. 1/2 inch x 150 foot roll. Each **A** \$6.50; 2 or more \$5.95 each

Instant Greenhouse



3897 Tomato Greenhouse*

Get the most from tomato plants with their own mini-greenhouses made from red, perforated plastic film. Allows air circulation and heat

retention for faster growing tomatoes. UV stabilizers are added for longer life.

- Enough for 6-7 covers.
 - Red colour aids in ripening.
 - 6 twist ties included.
 - Protects fruit from blight.
 - Try this with Peppers!
 - Protect against pests.
- Each pack **A** \$23.95

Individual Room Purification



- Reduces Bacteria & Viruses
- Removes Allergens
- Removes Smoke & Odours

5830 Pure Air 500*

Tabletop air purification. Designed to purify the air in an individual room, pureAir 500 uses three advanced technologies to eliminate bacteria, viruses, odours, smoke, pollen, mould, pet dander and more. These technologies help to sanitize everything in the air, embedded in walls, ceilings, floors, furniture, clothing, on counter tops and other surfaces. Operation is just as simple as its design; choose the continuous setting for a constant clean or use the burst setting automatically timed increases in purification to deal with tougher odours.

Each **A** \$275.95; 2 or more \$239.95 each

**Sharpens A Wide Range of Tools Like New!
A Must For All Garden Sheds!**

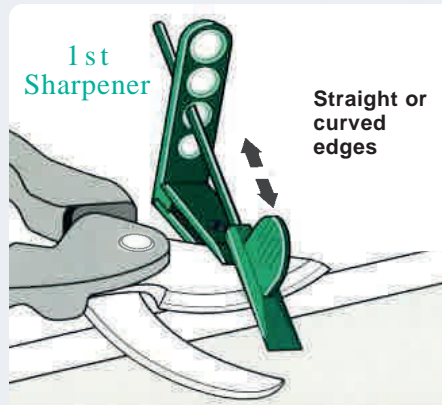

Restores the cutting edge of secateurs, pruners, loppers and pruning knives with either curved or straight edged blades. Clamps to the back edge of the tool blade and the grinding jig ensures sharpening to the correct angle.

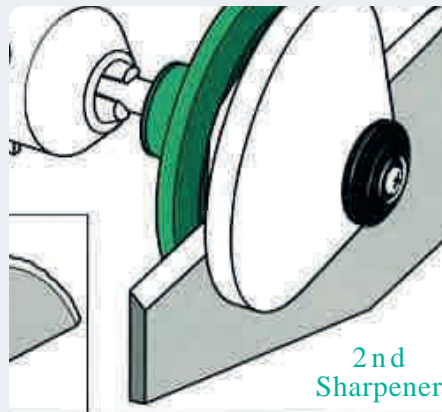

Fits to any power drill and produces a sharp new cutting edge on rotary mower blades in minutes without removing the blade from the mower! Also puts a keen edge on spades, hoes, lawn edgers and axes, making them much easier to use.



Sharpens most types of shears including stainless steel, long-handled, wavy edge and shears with a single cutting edge. Household scissors too!

3330 Multi-Sharp 3 piece Garden Tool Sharpening Kit*

All 3 tools above in one kit! Each kit **A** \$57.95; 2 or more kits \$52.95 each

*Manitoba customers, this page is taxable.

CALLA LILIES

DAYLILIES



NEW!
6300 California Red
 Dark pink flowers with yellow stamens, green foliage. Ideal for semi-shaded areas. Can be started indoors as a pot plant. Height: 45cm (18").
 Each **A \$10.95**



NEW!
6301 Dubai Nights
 Large, funnel-shaped, dark purple flowers with creamy margins. Dark green foliage with glossy white speckles. Ideal for semi-shaded areas, can be started indoors.
 Height: 45cm (18"). Each **A \$10.95**



NEW!
7131 Destined to See
 Cream yellow daylily with lavender eye and edge above yellow green throat. Easy to grow in various conditions, drought and heat tolerant once established. Each **A \$12.95.**



NEW!
7135 Kansas Kitten
 A compact daylily with magenta flowers and dark purple eyes. It reblooms and has a high bud count on well-branched scapes.
 Each **A \$12.95.**

photo courtesy of: Walters Gardens, Inc.

Tropical Beauties - New Supplier - larger bulbs



Large rich blooms with showy green leaves. Plants do best in semi-shaded areas. They can also be started earlier indoors as a pot plant. Plant outdoors after soil warms up, in a well-drained spot. Ht 45 cm (18 in). Note: Plant the bulbs near surface of soil to ensure bloom.

6300 California Red
6301 Dubai Night
6320 Morning Sun
 Prices for 3 above
 Each **A \$10.95**; 2 or more your choice **\$9.95 ea**
6330 Calla Collection
 1 each of the above 3, labeled **A \$26.25**

7140 Daylily Collection
 1 each of the above daylily, 2 labeled bulbs **A \$22.95**

NEW!

FEATURE DAYLILY

7137 Joan Senior
 Creamy white ruffled flowers. One of the best white daylilies. Sweet fragrance. Early - mid season. Reblooming
 1 **A \$11.95**;
 2 or more **\$10.95 each**

CANNA LILLIES

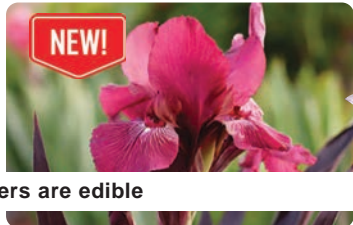

Canna roots/tubers are edible

Canna lilies are not winter hardy under Zone 7, it is advisable to pull the bulbs after a killing frost & store them for the winter!

6010 Peach Blush
 Apricot flowers on green foliage. Ideal for gardens and containers. Perfect for summer gardens.
 Your choice **A \$12.95 each**

6009 Pink Futurity
 Huge coral pink flowers with green and chocolate foliage. Ideal for gardens and containers. Perfect for summer gardens.

6014 Canna Collection
 1 each of the above cannas, 2 labeled bulbs **A \$23.95**

ACIDANTHERA



Fragrant Container Feature!

6295 Fragrant Gladiola
 Probably one of the most fragrant flowering bulbs you can grow. The white star-shaped flowers have reddish-purple eyes. Pot some Acidanthera bulbs up and place them near your front door so you can enjoy their sweet perfume as you come and go. Excellent for cutting and easy to grow. Up to 6 or more blooms on 60 - 90 cm (2 - 3 ft) stalks. Later blooming September beauty!
 1 pak (10 bulbs) for **A \$9.95**; 2 or more paks **\$8.95 each**

Manitoba residents: bulbs are taxable. *

GLAD MIXES



Blooms All Summer!
Plant bulbs in 2 week intervals to extend the blooming season! Add Sulphur to soil before planting!

LANDSCAPE MIX

Short 60-90 cm (2-3 ft) plants with large full size flowers. This novel type saves on staking and space, allows for compact bright display. Mix contains a rainbow of colours including white. Bulb size #1 (12-14 cm).

6250 Landscape Glad Mix*
25 for **A** \$21.95; 50 for **B** \$35.95; 100 for **C** \$64.95; 250 for **D** \$140.00; 500 for **E** \$235.00

EXHIBITION MIX

We feel this is the best Glad mixture offered at any price. Excellent selection of named varieties and seedlings. Ideal as a background plant in your flower gardens. Ht. 1.2 m (4 ft). Bulb size #1 (12-14 cm).

6285 Exhibition Glad Mix*
25 for **A** \$21.95; 50 for **B** \$35.95; 100 for **C** \$64.95; 250 for **D** \$140.00; 500 for **E** \$235.00



6200 Black Sea
Dark maroon flowers with a touch of white in the center.



6201 Snowdance
Snowdance returns to us for a second year. It has performed well for us as a promising cut flower with brilliant blooms on well proportioned flower spikes and stems.



6219 Bananarama
Rich, vibrant yellow flowers. These beautiful plants make striking accents in any flower border.



6202 Esta Bonita
A beautiful gladiolus with soft apricot-orange petals and a yellow center. The colors blend and shade beautifully, creating a pretty and eye-catching flower.



6203 Plum Tart
This hardy plant features tall stems with dramatic magenta-purple flowers and sword-like foliage, adding intense summer color and strong vertical elements to your garden.



6204 Careless
Large pale pink gladiolus with a creamy white throat and slightly ruffled petals.



6212 Green Star
Blooms in bright green flowers and is the perfect compliment to other colourful varieties.

GIANT GLADS*
1 pak contains 4 glads (1 colour only)
Any 1 pack **A** \$6.95 each
2 or more packs \$5.95 each



6240 Super Glad Collection*
One pak (4 bulbs) of each of the 10 named varieties, 40 bulbs (labeled) in total.
Collection **A** \$52.95



6205 Milka
Milka Gladiolus is an elegant and versatile garden accent with soft lavender and white colors, adding beauty to any space.



6221 Purple Flora
The velvet petals of Gladiolus Purple Flora are rich, royal purple. Elegant and majestic, this beauty will reign with statuesque power in the back of any sunny border.



6206 Chit Chat
Bright pink with white speckled throat.

Dinner Plate Dahlias For Giant Blooms!



6100 Mystery Day
Vibrant purple and white flowers perfect for large containers, adding a pop of color to any space



6116 Myrtle's Folly
Impressive! Narrow, twisted petals of peach, pink and yellow. Will provide a reliable supply of flowers that look perfect in a vase. Ht 90 cm (3 ft).



6101 Extase
Large two-toned (salmon-apricot) perfectly shaped flowers. Compact variety, medium green leaves.

PATIO DAHLIAS FOR BASKETS & BORDERS!

The most rewarding plant in your landscape! These massive new dahlias have been selected for their large flowers yet compact growth. Vigorous and fast growing with strong stems that require no staking. Flowers from mid-summer up to the first frost.



6123 Firepot
The bright and cheerful colouring reminds us of a summer sunset! Irresistible coral-pink petals with a neon-yellow base. The combination is so spectacular, you won't be able to resist cutting a few for the vase! Ht 30-90 cm (24-36 in).



6102 Cafe Au Lait
Stunning large flower on strong stem. Beautiful cream and peach hues. Ideal for borders and as cut flowers.



6103 Blue Bell
A top-performing decorative Dahlia. Truly beautiful large purple blue flowers. Very floriferous

DAHLIAS! For amazing blooms!

1 pack A \$7.95 each
2 or more packs \$6.95 each.
Dahlias 1 clump root

Easy-to-Grow Dahlias

Dahlia tubers will add an exotic and enticing touch to any garden or landscape. Our dahlia flowers await you, ready to burst into stunning displays of deep and radiant beauty. Dahlia bulbs (tubers) are planted in the spring, and produce loads of blooms the first year, all summer long. Dahlia flowers come in all shapes and sizes, blooms from 1" to over 12" across. Enjoy them in your garden and as cut flowers in your home. Must be dug and stored for the winter!

6175 Super Dahlia Collection All 8 Named Dahlias \$49.95



6104 Ferncliff Illusion
White flowers tipped purple. Clear green toothed foliage. Huge flowers on sturdy stems.



6130 Arabian Nights
One of the darkest of all dahlias, Arabian Night has been a cutting garden favorite for more than 60 years. The dusky, deep red petals give it a sultry beauty that adds depth and drama to every bouquet. Makes an excellent cut flower! Ht 1 m (40 in).

ACHILLEA



7036 Diadem

This snow white beauty produces a mass of pompon-shaped flowers on a neat, rounded shape and a compact height of 30 cm (12 in) tall. When you lightly prune the plant, it will rebloom. Ideal for containers, flower borders, and as a groundcover. Bees and butterflies friendly. Deer Resistant.

1 root **A** \$12.60;
2 or more 10.95 each

FLEECEFLOWER



7055 Giant Fleeceflower

The ideal perennial to make a bold statement in your garden! Will form a very large, bushy clump of bold green leaves topped with huge, creamy white, Astilbe-like flowers blooming for about 3 months. Delicately scented flowers. Amazing space filler that will help choke out weeds! Ht 1.8 m (6 ft).

1 root **A** \$12.95; 2 or more \$11.95 each

CAT MINT



7041 Chartreuse On The Loose

A perennial plant with bright chartreuse yellow leaves that provides season-long interest and produces lavender blue flowers all summer without needing to be cut back.

1 root **A** \$13.50; 2 or more \$12.50 each

FEATURE PERENNIAL



7144 Singing In The Rain

Copper colored semi-double flowers. Attractive to pollinators. Vigorous grower.

1 root **A** \$54.95; 2 or more \$52.95 each

JOE-PYE WEED



7061 Baby Joe

A mid-sized Joe-Pye Weed with magenta-pink flowers that attracts butterflies. Ideal for smaller gardens, containers, and wet areas. Offers winter interest and great for cutting.

1 root **A** \$11.95;
2 or more \$10.95 each

ECHINACEA



7014 Ruby Star

Strong stems rise above the dark green, lanceolate foliage while prominent copper cones attract goldfinches and pollinators for several months.

1 root **A** \$13.95;
2 or more \$12.95 each

PEONIES



7145 Lemon Chiffon

Unusual butter-yellow flowers on strong upright stems. Semi double flowers first year, full double the years after.

1 root **A** \$34.95; 2 or more \$32.95 each



7146 Joker

Double soft pink flower (matures to pure white) with candy pick edges.

1 root **A** \$27.95; 2 or more \$26.95 each

DELPHINUMS



7021 New Zealand
A series of shorter delphiniums with high-quality appearance. Features sizeable spikes of various colored flowers on strong stems and bushy foliage.



7024 Blue Buccaneer
Dark electric blue flowers with black eyes on strong spires. Some lighter blues may appear. More compact than 'Cobalt Dreams' with intense blue color.



7093 Dark Side Of The Moon
Attractive mound of foliage with deep chocolate burgundy leaves. Yellow leaves with dark margin turn completely dark as they age. Raspberry buds bloom into rosy purple flowers. Grows best in full sun with adequate moisture. Can also grow in shade.



7153 Purring Tiger
Compact Siberian Iris with dusty lavender flowers and golden yellow petals lined with purple veining. Blooms in early summer, reaching a height of about 1.5 feet.

MONARDA



7115 Bee Happy
Simply glorious, with its healthy dark-green foliage, pure red flowers and purplish bracts. As a bonus, the foliage has a sweet scent that bees can't resist. Ht 45-50 cm (18-20 in).

Gardener's Choice Perennials Mix 'n Match - You choose!

1 pack **A** \$10.50 each.
2 or more packs \$9.50 each.
(each pack has one root)



7154 Florentina Blue
A rare delightful variety, especially fine for massing as well as for cutting. Tall growing; with very large full formed flowers of soft lavender and deep purple.

GAILLARDIA



7076 Arizona Apricot
The bronze-orange flowers are outward facing and beautifully edged in golden yellow. Strong stems and large, fragrant flowers
1 root **A** \$17.95; 2 or more \$16.95 each

VERONICA



7023 Ulster Dwarf Blue
Mildly fragrant royal blue flower spikes bloom in clusters above dense, dark green foliage. A great plant for the front of a perennial border, along a walkway or in pots. Deer resistant! Ht 30 cm (12 in).

POPPY



7020 Central Park
Lavender-purple, large ruffled flowers with dark purple marks at the base of the petals. Compact growing habit. An exceptionally ruffled double layer of petals gives an elegant look to this stunner. Ht. 60 cm. (24 in).

ASCLEPIAS



7006 Soulmate
Pink Petals surrounding a white heart.

HELIOPSIS



7085 Red Shades
Dark chocolate foliage with fiery orange-red blooms. Abundant summer blooms attract pollinators and make beautiful cut flowers. Height of 60 cm (24 in).

Combine your order with a friend and Save!
We at T&T Seeds are doing our best to keep prices down! But with freight and handling costs shooting sky high, it is tricky. Why not combine your order with a friend and share the shipping costs and also get in on the 10% discount for larger orders (see discount rule, page 5). Remember combined orders are only shipped to one address.

FULLY DOUBLE LILIES

ASIATIC HYBRIDS

All the hardiness and vigor of the traditional Oriental Lilies that we love, but with stunning double flowers!

“Hardest” Easiest-to-grow!



7207 Primrose Hill E-M
Majestic three-toned flowers. White with golden mid-rib and lilac edges. Fragrant.

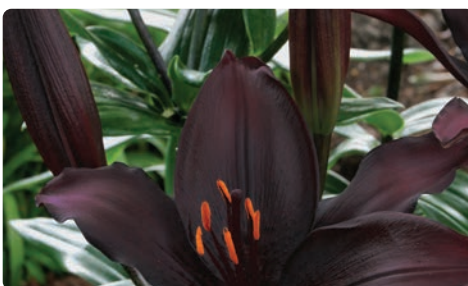

7230 Black List E-M
Pointed and slightly ruffled petals give the flowers a starry appearance. Shiny, satiny petals of deep-burgundy colour with fluffy orange stamens. Ht 80 cm (32 in). Prices below.



7232 Golden Matrix E-M
A fantastic, dwarf lily. These bright golden-yellow flowers are speckled in the center throat of the bloom. Ht 40 cm (16 in).



7201 Trendy Santiago M-L
Classic pink colored flowers with dark maroon center. Excellent for container growing.



3769 Neem Oil Concentrate
Neem oil is an incredibly useful product to have on hand if you're a gardener, plant enthusiast or even if you're just starting to get into plants. A lot of leaf shine products or household items (coconut oil, banana skins and even milk) can block the leaves' ability to photosynthesize. However because neem oil is a natural product, using a little can help with a natural shine while cleaning the leaves. The best method is to spray a diluted mixture onto the leaves, and then gently wipe them down. This will help remove any buildup of dust and dirt and help your leaves look shiny and healthy. 1 bottle makes 20L.

Prices for each 2 varieties above
1 Pack (2 bulbs) **A** \$9.95

Prices for each 2 varieties above
1 Pack (2 bulbs) **A** \$9.95

7235 Matrix Collection
1 pack each of the above 2, 4 labeled bulbs **A** \$17.95

7245 Trendy Santiago Collection
1 pack each of the above 2, 4 labeled bulbs **A** \$17.95

100 ml **A** \$16.95;
2 or more \$15.95 each



7241 Forever Susan M-L
Unique colour and a distinctive petal shape make this a must-have for the Lily connoisseur! Vibrant mahogany-red petals with bright orange accents. Height 60-90 cm (24-36 in). Prices below.



7335 Morden Butterfly Lily* LM
Cherry red flowers on 1.2 m (4 ft.) stems. Blooms are large, recurved and downfacing. Secondaries grow regularly each year, meaning you get more blooms! Ht 1.5 m (5 ft.)

1 pak (2 bulbs) **A** 9.95 ea

7340 Butterfly Collection
1pkg. of each of the above 2 lilies, 4 labeled bulbs **A** \$17.95

LILY COLLECTION



7275 Showcase Asiatic Collection
A splendid variety of colours and flower shapes. These vigorous healthy bulbs will bring glorious colour to the garden.
Pack 6 bulbs **A** \$14.95; Pack 12 bulbs **B** \$21.95;
Pack 24 bulbs **C** \$39.95

MB residents: This page taxable

ORIENTALS

"Elegant" Wonderfully Fragrant! Less susceptible to Lily-Beetle!



7224 Eyeliner M-L

Pure white flowers have green throats and some speckles. Petals are outlined in burgundy.



7202 Matrix M-L

Orange-red flowers with soft orange eye-zone. 60-70 days to flower.



7302 Muscadet M-L

An irresistible exotic beauty. Large, fragrant white blooms with pink spots, it's easy to see why this lily is so well-loved! Ht 80 cm (32 in).



7200 Avalon Sunset E-M

The bronze-orange flowers are outward facing and beautifully edged in golden yellow. Strong stems and large, fragrant flowers

Prices for each 2 varieties above

1 Pack (2 bulbs) **A** \$9.95

Prices for each 2 varieties above

1 Pack (2 bulbs) **A** \$9.95

7210 Whiteout Collection

1 pack each of the above 2, 4 labeled bulbs **A** \$17.95

7315 Sunset Collection

1 pack each of the above 2, 4 labeled bulbs **A** \$17.95

BORDER LILIES



7290 Rozalynn E-M

Compact, delightfully fragrant pink blooms with a white center. This tropical-looking Asiatic Lily has a compact habit, ideal for growing in patio containers or for edging paths and borders. Ht 45 cm/18 in.

Pack 10 bulbs **A** \$21.95; Pack 20 bulbs **B** \$40.95; Pack 40 bulbs **C** \$75.95

RUSSIAN SAGE

TROLLIUS

SALVIA

SEDUM

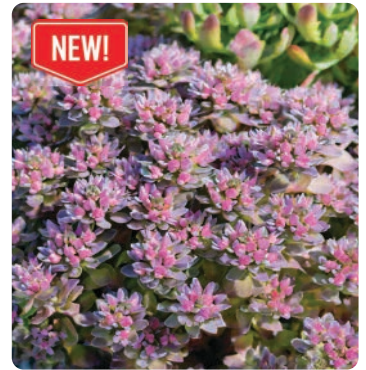

7029 Sage Advice
Rich lavender purple flowers are produced on strong, upright plants filled with oval-shaped, notched leaves. This is early to bloom

7094 Alabaster
Charming & unusual, with globes of pale creamy-yellow flowers. Prefers damp soils. Trollius is known for attracting bees and other pollinators. Well suited to a woodland garden with ferns and astilbes. Ht 45 cm (18 in).

7141 Salvia Bumbleberry
'Bumbleberry' produces dark fuchsia pink flowers on dark wine purple calyxes on a petite habit of attractive deep green foliage. This cute sized package is perfect for the front of the border or grown in a quart pot.

7087 Sedum Sapphire
A compact sedum with strong stems that changes color from blue-purple to deep purple. It produces clusters of rosy pink flowers in the fall.

1 pack (1 root) **A** \$14.95
2 packs or more \$12.95 each.

1 pack (1 root) **A** \$14.95
2 packs or more \$12.95 each.

1 pack (1 root) **A** \$14.95
2 packs or more \$12.95 each.

1 pack (1 root) **A** \$14.95
2 packs or more \$12.95 each.

LIATRIS

ASTILBE

PHLOX



7189 Ice Cream
Masses of fluorescent shades of soft pink. Feathery plumes sit above glossy, dark green foliage in mid to late summer. Great for the back of your border or in containers. Ht 75 cm (30 in).

7096 Yucca Montana
Stout plants with woody stems or stem-bases, often tall, even tree-like, the long and narrow leaves crowded in rosettes at ends of stems or branches, a stout rapidly growing flower stalk arising from the rosette.

1 pack (2 roots) **A** \$16.95
2 packs or more \$15.95 each.

1 pack (2 roots) **A** \$17.95
2 packs or more \$16.95 each.

BLEEDING HEART

FERN



7185 Old-Fashioned
Perfect dainty heart-shaped pink blooms in late spring. Fairly bushy plants. Ht 90 cm (3 ft).

7048 Native Fern
A hardy and beautiful outdoor Fern. Ideal for shady spots where nothing else will grow. Ht 90 cm (3 ft).

1 pack (2 roots) **A** \$18.95
2 packs or more \$17.95 each.

1 pack (3 roots) **A** \$16.95
2 packs or more \$15.95 each.

7080 Kobold
Violet blue flowers. Naturally short variety, USA Native.

1 pack (5 roots) **A** \$14.95
2 packs or more \$12.95 each.

7026 Cotton Candy
Features clusters of cotton candy pink flowers that bloom from early summer to fall. A new hardy garden phlox with mildew resistance

1 pack **A** \$18.95;
2 packs or more \$17.95 each.

HOSTA

LUNGWORT



7120 Atlantis
A showy sport with wider edges than its parent, featuring dark green leaves with golden yellow margins that brighten with sunlight. Majestic specimen with lavender flowers.
Each **A** \$18.95; 2 or more \$17.95 each



7102 First Blush
A hosta with absolutely unique colouring, new leaves emerge in spring with a purple-red hue, prominent on the mid-rib. As summer progresses, most leaves will slowly turn to a pure green. Ht 40 cm (16 in).
Each **A** \$18.95; 2 or more \$17.95 each



7034 Pink A Blue
Featuring pink flower buds that open to medium blue flowers in spring, with silver-spotted foliage that brightens shade and is resistant to deer and rabbits.
Each **A** \$15.95; 2 or more \$14.95 each



7119 Hudson Bay
Improved hosta with wider, brighter blue margin and apple green jetting. Heavy substance leaves with good slug resistance. Large mound of attractive foliage with near-white flowers in early summer.
Each **A** \$18.95; 2 or more \$17.95 each



7103 Lipstick Blonde
Add some colour to your shade gardens. Long, wavy leaves of vibrant yellow contrast beautifully with red stems to give it a unique look. Ht 40 cm/16 in
Each **A** \$18.95; 2 or more \$17.95 each



7037 Northern Exposure Lime
A hardy plant with lime green leaves that stay attractive all season, and produces soft red flowers in early summer.
Each **A** \$15.95; 2 or more \$14.95 each

7110 Blush Collection
1 each of the above 2, labeled **A** \$34.95

All perishable stock is shipped for spring planting only.
Stock is available up to June 15, 2023 (approximately).
While quantities last.

7050 Bay Collection
1 each of the above 2, labeled **A** \$34.95



7038 Northern Exposure Purp
A hardy plant with purple leaves that turn silver, featuring deep purple veining. It also produces soft pink flowers in early summer.
Each **A** \$15.95; 2 or more \$14.95 each

SEDGE GRASS

REED GRASS



7190 Rosy Sedge

A versatile native sedge that thrives in wet or dry soils, making it perfect for borders, ponds, rain gardens, hillsides, and under trees. Features star-shaped seed clusters and dense foliage.

1 root for **A** \$12.95;
2 or more \$11.95 each

7199 Karl Foerster

A vertical masterpiece and provides wonderful contrast amongst low shrubs and perennials. One of the first grasses to start growing in the spring, an early bloomer, which is an asset in areas with a short growing season. The flower spikes change colour through the season and remain on the plant until winter snow brings them down. Ht 1.5-2 m (4-6 ft).

1 root for **A** \$12.95;
2 or more \$11.95 each

LITTLE BLUESTEM

YELLOW PRAIRIE GRASS



7194 Blue Paradise

The glaucous blue-green foliage begins to take on scarlet red tones in late summer, turning a deeper red-purple through the fall. Tiny, tan seed heads appear in early fall on the top half of the stems.

1 root for **A** \$12.95;
2 or more \$11.95 each

7196 Golden Sunset

A tall native selection with vertical landscape application, featuring wide leaves and long golden seedheads that add winter interest.

1 root for **A** \$12.95;
2 or more \$11.95 each

FEATURE GRASS



7197 Twilight Zone Grass

Iridescent, silvery mauve colour that appears in midsummer. These beautiful pastel tones intensify in fall when bright purple highlights appear. Plant height .6-1.2 m (2-4 ft) with a spread of 60 cm (2 ft).

1 root for **A** \$12.95; 2 or more \$11.95 each

Hardy Climbing Rose!

8557 Climbing Rose- Above & Beyond

If you live in a colder climate where Roses sometimes struggle in the spring season, this Rose is for you! Blooms right on schedule each year, clusters of orange buds open to large, pale apricot blossoms that envelop this vigorous, cold-hardy climber. The 7 cm (3 in) semi-double to double flowers arrive in spring or summer followed by intermittent blooms later in the season. Mild fragrance and on its own root.

Each **A** \$44.95; 2 or more \$39.95 each



About T&T Perishable Stock

We purchase our perishable stock from all over the world. All the stock is shipped into our Headingley warehouse, packed and stored at controlled temperatures. This ensures the stock is kept dormant and fresh, right until we ship your order. We buy stock that is hardy to zones 2 and 3. If they are not, we state this in the description. Please, upon arrival of your order make sure you open and inspect it immediately to ensure everything is to your satisfaction. If not, let us know immediately so we may correct it.

BEAUTIFUL HARDY ROSES



From Uncle Jerry, award-winning Rose-breeder and T&T Founder

His All America Selection

8550 Love & Peace

A stunningly beautiful All-American hybrid tea rose bred by Uncle Jerry. The mildly fragrant blooms are a bright yellow with cerise pink petal edges with no two flowers exactly alike. Growing on an upright, medium sized bush, this beauty is a great repeat bloomer. Colour softens to creamy yellow and warm pink. Ht 1.2 m (4 ft). (Hybrid Tea)

Climbing Rose



Strong Fragrance

8564 Morden Blush

Considered one of the most refined of shrub roses, this gem produces clusters of exquisite tea-like flowers that fade from the softest pink to a hint of ivory; hardy; beautiful glossy green foliage; needs full sun and well-drained soil.



8529 JP Connell

Delicate, fragrant lemon yellow blooms fade to creamy-white with yellow centers, borne singly or in clusters on almost thornless stems. A hardy, vigorous shrub. that has resistance to powdery mildew. Ht 1.25m (4ft) tall, 60cm (2ft) wide. From the Explorer Series. (Shrub)



8513 Canadian Shield

A beautiful "made in Canada" shrub rose. Originally developed in Manitoba, so you know it's hardy! Ideal as a centerpiece in the garden or featured in a large container. Loads of lightly fragrant and double red blooms atop dark green foliage! Ht 1.25 m (4 ft). (Shrub)

Gardener's Choice Roses

Mix 'n Match You choose!
Any 1 Rose (this page only)
A \$29.95 each.
2 or more \$25.95 each.

Low-Maintenance and Continuous Bloom All Summer Long.



8565 Oscar Peterson

Lovely white semi-double blooms with a hint of butter yellow and golden centers appear throughout the season on a low bushy shrub; well suited for landscaping, for containers, or a low flowering hedge; a very hardy variety



8580 Campfire

A beautiful variety producing clusters of pink and white blooms with intense yellow centers; habit is upright with vigorous dark green glossy foliage that is very resistant to blackspot; all roses need full sun and well-drained soil

8566 Lambert Closse

A small upright shrub, Rosa 'Lambert closse' produces double blooms that resemble classic hybrid teas. The double pink roses are mildly fragrant and present in clusters of 3. First flowers in June, with good repeat blooms. The foliage is a very glossy green.

8568 Aurora Borealis

Aurora Borealis®, is black spot resistant and cold hardy with beautiful pink flowers comprised of 20 petals. Plants grow upright to about a metre in height and width. This rose continuously blooms throughout the season with self-clean flowers.



GARDENER'S CHOICE VINES

Mix 'n Match - You choose! 1 vine A \$21.95 each. 2 or more vines \$19.95 each. (This page only)



CLEMATIS - The queen of vines



One of the most popular of all climbing vines! The flowers are irresistibly beautiful and will add beauty to any landscape. Ideal grown on fences, arbors, pergolas and obelisks. Hardy 2 year old roots. Bloom all summer!

7415 Rouge Cardinal

You will love the rich, velvety crimson flowers with a frilly center of gold. A vigorous grower once it takes off, be sure to give this clematis an arbor, fence or trellis to climb on and twist around. Blooms appear in early summer and then repeat throughout the summer. Deer and rabbit resistant. Grows up to 2.5 m (8 ft).

7421 Jackmanii

Deep purple blooms that will flower all season. Will bloom first on new growth beginning in midsummer, and then again on new shoots in early fall. Large-flowered variety, 12-15 cm (5-6 in) in diameter. Ht 2.5 m (8 ft). Long time favourite!

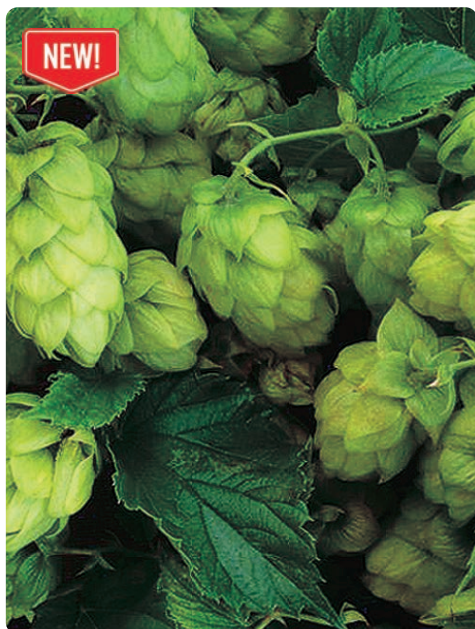

8305 Cascade Hops Vine

Cascade is the hop that made hops famous. It features excellent vigor and yield and when brewed exudes a distinct spicy citrus aroma with hints of grapefruit. Well suited to just about any ale and lager, its use is particularly popular in American Pale Ales.



8307 Nugget Hops Vine

Hardest and fastest growing hops, 6 m (18 ft) in five weeks! Great decorative vine. Needs support, producing excellent green foliage with golden-yellow, cone-shaped hops. Fills in quickly.



8303 Virginia Creeper

Virginia creeper is basically bulletproof. Drought tolerant, it grows in any soil (poor, rich, wet, dry) or light (sun or shade) and deer leave it alone. Virginia creeper has tiny octopus-like feet that cling to almost anything and needs no trellis or fencing for support. This vine is noted for its brilliant burgundy-red fall foliage which intensifies in full sunlight. A fast growing, hardy plant to transform any landscape quickly!

Manitoba residents: Vines & perennials are taxable

HEDGING



Customer Favourite!

8408 Villosa Lilac*

A beautiful, late, pink flowering Lilac which makes an excellent hedge or windbreak. Hardy and non suckering trees thrive under most conditions. Mature height 3 m (10 ft). 30 cm (12 in) plants. Plant 45 cm (18 in) apart.

Bundle of 2 **F** \$12.50; 10 for **A** \$43.95; 25 for **C** \$96.95; 50 for **G** \$180.00; 100 for **H** \$340.00



8403 Cotoneaster*

Makes an ideal low hedge. Constant favourite for use as a 1-2 m (3-6 ft) hedge. Shiny dark green leaves in summer change to glowing colours in autumn. Likes acidic soil. 30 cm (12 in) plants. Plant 45 cm (18 in) apart.

Bundle of 5 **F** \$29.95; 10 for **A** \$46.95; 25 for **C** \$99.00; 50 for **G** \$190.00; 100 for **H** \$345.00

PREPARING YOUR NEW TREES FOR WINTER

So you're considering purchasing dormant stock this spring? After a successful spring/summer of nurturing your trees, the question will arise. What needs to be done to ensure it is ready for our cold Canadian winters?

In the fall, the nutrients and energy produced by the leaves begins to push back into the roots for winter storage. This is what will help put the tree into dormancy and keep the tree alive until spring:

1. Stop fertilizing in late August so the tree isn't actively trying to shoot new growth as first frost closes in.
2. Water trees well throughout the autumn up until the ground freezes. Newly planted trees will need more water than mature trees. Water acts as an insulator making plant cells stronger against cold damage.
3. Consider applying mulch around your new trees. You'll want to focus on keeping the circumference within the trees drip-line while avoiding piling the mulch against the trunk. Mulch helps insulate the roots during the cold winter and it also slows water loss from the soil.
4. If your area is particularly snowy, you can wrap the tree for additional protection through the first few winters.

HEIRLOOM WINDBREAK



8411 Common Caragana*

A grand old standby that has proven durability! Widely used across the prairies as a reliable windbreak, very drought tolerant and hardy. Bright yellow flowers in May. Mature height 6 m (18 ft). 1 m (3 ft) plants. Plant 1.8 m (6 ft) apart.

Bundle of 5 **F** \$19.95; 10 for **A** \$35.95; 25 for **C** \$79.95; 50 for **G** \$150.00; 100 for **H** \$275.00

* Manitoba residents: shrubs and hedging are taxable

WINDBREAKS - MEDIUM & MEDIUM TALL TYPES



Amazing Fall Colour!

8407 Derek's Tatarian Maple Tree

Its bright red maple leaves are stunning in October and will stand-out in any landscape setting. These trees with their spectacular fall colour have a very distinct branching pattern that provide for a striking and dramatic display. Mature height 8 m (25 ft) and width is 8 m (25 ft).

1 for **A** \$23.95; 5 for **B** \$93.95; 10 for **C** \$179.00

8406 O'Canada Tatarian Maple (Hedging Size)

Everything about this small shapely looking tree is highly ornamental - flowers, bark, foliage, and even the seeds themselves. Yellowish-white flowers appear in April to May in 5 to 7 cm (2 to 3 in) panicles. Dense medium to dark green foliage turns to a vivid scarlet autumn. Very rapid growing. Mature ht 8 m (25 ft). Plant 60 cm (2 ft) apart for hedge, 3 to 4 m (9 to 12 ft) for windbreak. 35 cm (14 in) plants. Pictured above.

5 for **F** \$21.25; 10 for **A** \$35.95; 25 for **C** \$81.95; 50 for **G** \$155.00; 100 for **H** \$275.00

DID YOU KNOW?

The most common issue that occurs with dormant tree and shrub stock is that they are slow to break dormancy. Patience is absolutely crucial to the care and maintenance of your perishable stock. To give your plants an extra boost, try the Liquid Seaweed Concentrate to give them that extra push they need to break dormancy.



**HAVE A QUESTION?
We Can Help!**

send us an email
garden@ttseeds.com

FEATURE WINDBREAK



Amazing Dwarf Poplar!

8395 Paskapoo Poplar

Paskapoo is a very short, broad headed tree with stout stumpy growth. The branching is very lateral - giving it good winter interest. Due to it's short stature there is little chance of it out-growing an urban site. Maximum size will be 6 m (20 ft high), 5 m (15 ft) wide. Fall colour is bright yellow. The tree maintains a strong Balsam Poplar scent through the growing season. This tree is seedless, so no mess! Plants approximately 35 cm (14 in) at shipping time.

Bundle of 2 **A** \$26.95; 4 for **B** \$48.95; 6 for **C** \$65.95



Simple but effective options to easily feed your trees and shrubs!

We are often asked for the best fertilizer to feed trees and shrubs. Here are 3 of our top fertilizers that can be applied every 3 weeks! Any one of these will do the trick, you choose your favourite.

For shrubs:

Apply 1 full cup around each shrub base and water in!

For trees:

Apply 3 to 4 full cups spread around each tree base and water in!

8414 Cheyenne Russian Olive

A great contrast plant for your landscape. The berries and leaves often remain well into winter. Helps fix nitrogen in the soil. Often planted as a windbreak around orchards and gardens. Also excellent along highways as they have a higher salt tolerance. Quick growing. Mature ht. 5 m (16 ft). 35 cm (14 in) plants. Plant 60 cm (2 ft) apart.

5 for **F** \$25.95; 10 for **A** \$42.95; 25 for **C** \$96.95; 50 for **G** \$185.00; 100 for **H** \$345.00

3175 Sky Rocket Soil (pg.102) Enhancer*

1 kilo **A** \$15.75; 5 kilo **B** \$39.95

3210 Wormgold* (pg.65)

2 kilo bag **A** \$12.25; 5 kilo bag **B** \$21.50

3272 Alfalfa Gold* (pg.66)

2 kilo **A** \$18.35; 5 kilo **B** \$35.75

Note: These items ship with Seed & Sundries.

*Manitoba residents; this page taxable



8355 Virtual Violet Lilac

Shiny violet leaves, deep purple stems, raspberry-purple buds, and fragrant violet flowers make Virtual Violet a standout new lilac. The leaf petioles remain violet well into the summer, and the dense, upright habit makes it a great choice for a hedge or use in foundation plantings. Ht 1.8-2.4 m (6-8 ft.) & spread 1.5-2 m (5-7 ft).



8335 Incrediball Hydrangea (White)

New and improved 'Annabelle' hydrangea with strong, beefy stems and loads of massive blooms. Stronger stems to eliminate flop, but along with that came incredibly large blooms too! These are hardy hydrangeas that bloom on new wood, so even if killed to the ground by extreme weather they will still produce summer flowers. Mature ht 1.4 m (5 ft).



8340 Vanilla Strawberry Hydrangea

Newly introduced 'Vanilla Strawberry' produces stunning 10 inch blooms throughout the summer on both new and old stems. The enormous clusters of flowers start out a creamy white, changing to a soft pink and finally to a ripe strawberry-red as they mature. Blooms from June to first frost. Height 1.8 m (6 ft)



8330 Invincibelle Ruby

The dark burgundy red flower buds of Invincibelle Ruby open to a two-toned combination of bright ruby red and silvery pink. The foliage is extra dark and stems are strong, making this new hydrangea a gem in any garden.

FEATURE SHRUBS
 Mix 'n Match
 You choose!
 1 shrub A \$26.95 each.
 2 or more shrubs
 \$24.95 each. (This page only)



8317 Kodiak Black

This tough, easy-growing shrub is a standout with its dark burgundy-black foliage. This is a durable native that thrives in sun or shade, and is a very useful landscape plant.



8344 Celtic Pride Siberian Cypress

Features a no prune form, its ability to perform in sun, partial sun or shade and its' deep green summer colour that can fill the roughest, driest, most gnarly areas of the landscape with a carpet of green. In the winter the colour transforms to a striking bronze shade. This easy care, drought tolerant, deer resistant beauty with the soft, feathery foliage is one of the easiest plants you'll ever grow. Growing just 30 cm (1 ft) tall.



Perfect For Smaller Spaces!

8365 Pinkini Lilac

An outstanding dwarf lilac cultivar resulting from a cross between 'Charisma' and 'Miss Canada'. Abundant bright pink panicles on a compact bush. Non suckering. Mature height 1.5 m (4-5 ft), and spreads 1.25 m (3-4 ft).



8336 Little Lime Punch

Similar to Little Lime®, its blooms emerge lime green, but they mature a little differently. Flowers change progressively from the bottom up in a gorgeous array of white, light pink, and rich Hawaiian Punch red!



T&T Seeds - 10 Thousand Tree Project

Trees need our help! Forest fires, snowstorms, insect problems and drought have caused our trees to suffer. We have lost an alarming amount of trees across Canada! We are continuing the 10 Thousand Tree Project to support biodiversity, clean air and a healthy water cycle. With our variety of hardy selections you can plant more trees in your community. All of our windbreak, ornamental and fruit trees can fit into any type of landscape and provide you with the satisfaction you have contributed back to the environment. Trees offer a lasting legacy that will continue to benefit future generations.



Seedles

8385 AC Sundancer Poplar

This exciting new poplar is perfect for small lots and acreages. It is narrow, fast growing, disease-resistant, with dark green foliage and no seeds. This gem is the result of breeding work done in Saskatchewan by the Prairie Farm Rehabilitation Administration, which they had released for the 2014 season. This is a superior, new generation poplar and will be sold out quickly. Order early. Mature height of 12 m (40 ft), spreading 3 m (10 ft). Approximately 37 cm (15 in) plants. Prices below.



Fastest Growing Hybrid & No Seeds

Watch for mix n' match packages! Page 88 & 89

8375 Poplar Green Giant

Need a big tree in a hurry? This is the one! Very hardy. Has a Northwest Poplar like shape and has grown up to 2 m (6 ft) in a year. Leaves reach almost dinner plate size. Best of all the tree is seedless! Drought tolerant and very hardy. Better than Northwest Poplar, which is bud gall mite prone, and Brooks #6 which is canker prone. Excellent as a feature tree. Mature height 20 m (60 ft). Approximately 37 cm (15 in) plants. Space at least 5 m (15 ft) apart. Prices below.

Windbreaks - All types for better protection!



8387 Paper Birch

The growth rate of this tree makes them the preferred trees to plant in areas where trees were lost to fire, and in areas where many trees were cut down. The striking distinction of its' white bark year-round makes a unique statement. Once mature the trunk turns white, the bark actually "peels" into small sheets. Mature size is 25 m (82 ft) tall and 40 cm (1.3 ft) in diameter. Approximately 37 cm (15 in) plants.



8445 White Willow

Beautiful sparkling silver foliage shimmers in the softest breeze! This fast growing willow is drought tolerant and very adaptable to many different soil types. Bark is dark gray with deep lengthwise fissures, very distinct. Slight weeping habit also! Mature size is 10 m (30 ft) tall and wide. Approximately 30 cm (12 in) plants.

Prices for all trees this page.

2 for **F** \$25.95; 5 for **A** \$57.95; 10 for **B** \$107.95; 25 for **C** \$254.00; 50 for **G** \$475.00

Manitoba residents: shrubs and hedging are taxable

Extra Shipping: Due to the size and weight of some perishable stock an oversized or overweight shipping cost can occur.

This applies to all apple, pear and plum trees automatically. This will also apply to larger orders due to weight. You will be notified if this affects your order.



8435 Lancelot Shelterbelt Willow

One of the best shelterbelt willows! Very drought tolerant and will not drop its branches as easily as other willows. The foliage is a rich green, with dark red-dish brown branches. Extremely fast growing. Mature ht 10 m (30 ft). Plant size 60 cm (2 ft). Space 3 m (10 ft) apart.

Prices for above trees.

2 for **F** \$25.95; 5 for **A** \$57.95; 10 for **B** \$107.95; 25 for **C** \$254.00; 50 for **G** \$475.00



Watch for mix n' match pricing packages!

8380 Little Leaf Linden

One of the very best lawn trees for home landscapes, forming a tight pyramid throughout life, with highly fragrant yellow flowers in early summer when few trees bloom; excellent size for small properties or as a street tree, hardy and adaptable. Mature size is 15 m (50 ft) tall and a 9 m (30 ft) spread.

Not only are trees essential for life, but as the longest living species on earth, they give us a link between the past, present and future.



8425 Black Hills Spruce

Growing naturally dense and thick without shearing, this spruce is super hardy to zone 1. Works well as a windbreak/shelterbelt, privacy screen, accent planting, and even as a Christmas tree. Mature ht 20 m (60 ft). Plant size 30 cm (1 ft). Space at least 10 m (30 ft) apart.

Bundle of 3 **A** \$44.95; 6 for **B** \$76.95; 12 for **C** \$144.95



8405 Japanese Tree Lilac

One of the most striking specimen trees used in landscapes! A profusion of fragrant, perfect, creamy-white fragrant flowers and cherry-brown bark create quite a spectacular display. Mature ht 6 m (20 ft), spreads 4 m (13 ft). 30 cm (12 in) plants. Space at least 4 m (12 ft) apart.

5 for **A** \$31.95; 10 for **C** \$56.95; 25 for **D** \$132.95; 50 for **G** \$250.00



8420 Colorado Spruce

The most popular full size evergreens. Very symmetrical and varies in colour from silvery green to blue. Drought resistant and grows well in a variety of soils. Grows best in full sun. Mature ht 15 m (50 ft). Plant size 30 cm (12 in). Plant 3 m (10 ft) apart.

Bundle of 5 **A** \$32.95; 10 for **B** \$57.95; 25 for **C** \$132.95



8460 Lace Weeping Willow

Very hardy! Graceful branches spread 8 m (25 ft) and produce rich glossy green foliage. Young branches are bright golden yellow. Hardier with more consistent weeping features than Prairie Cascade. Mature ht 10 m (30 ft). Plant size 60 cm (2 ft). Space at least 7 m (20 ft) apart.

Each **A** \$23.95; 2 or more \$20.95 each.

HARDY SEMI-SWEET CHERRIES



8041 Rose Cherry

Back by popular demand! This is an extremely hardy cherry tested in prairie winters. Will produce huge amounts of dark-coloured big (5 to 7 grams each), small-stoned, aromatic, juicy fruit with strong sweet/tart flavour on a bush that reaches 2 to 3 m (6 to 9 ft). Filled with blossoms in late May, fruit ripens in August. Great for pies, wines, juices, jams and jellies. Self-pollinating.

Individual pricing in yellow box



Feature Cherry

From the University of Saskatchewan!

8058 Romeo

Another new cherry from the University of Saskatchewan from the Romance series! Romeo is a rich dark red to black cherry, similar to Carmine Jewel, just a bit later in ripening. Ideal for fresh eating or processing. Also has been the best new variety for juice production! A true dwarf with mature size of 2 m (7 ft) tall--a bush-like habit. Does not sucker! Self-pollinating. Individual pricing in yellow box



Largest Fruit!

8056 Cupid

A new choice from the University of Saskatchewan for a sour cherry. The Cupid has one of the largest fruits of all the hardy cherry trees. Excellent for fresh eating with very good flavour. Good for processing. Blooms one week later than other SK cherries. White flowers. Height 2-2.7 m (6-8 ft). Self-pollinating. Individual pricing in yellow box



Highest Yield! From the University of Saskatchewan!

8059 Juliet

An excellent introduction from the University of Saskatchewan with a mature height of 2.4 m (8 ft). Beautiful dark red fruit (approx. 5 grams) that is excellent for fresh eating, cooking, baking and making jams and jellies. Juliet Cherry features showy clusters of fragrant white flowers along the branches in mid spring. Self-pollinating. Individual pricing in yellow box



8061 Evans Cherry

An extra-hardy, natural dwarf cherry tree with a mature height of 3-4 m (10-12 ft). Produces loads of big, semi-sweet rich red Cherries. Ideal for fresh eating, jams, jellies, pies, sauces and wines. Flowers are 2 cm (1 in) and will form in tight clusters, providing a beautiful spring show. Self-pollinating. Individual pricing in yellow box

<p>Individual Cherry Tree pricing 8041 to 8061</p> <p>Each 30 cm (12 in) A \$19.50</p>		<p>Cherry "Orchard" Special</p> <p>Choose 3 or more of any of these cherry trees</p> <p>\$17.50 each</p>
--	--	--

MULTIPLE CHERRY PITTER



3750 Cherry-It Pitter*

Pitting cherries can be slow, messy and frustrating. It may take several tries to get the pit out and the stress on your hands is tiring, not to mention the juice splatter everywhere. The Progressive International Cherry-It Pitter cleanly pits 6 cherries at once, dropping the cherry pits into a clear base container that captures all the mess. Plus the simple stapler like motion of the cherry pitter requires little effort and is easy on hands. Imagine enjoying delicious cherries in 1/4 the time.

Each A \$21.95; 2 or more \$20.95 each

HARDY SWEET CHERRY



8063 Nanking Cherry Windbreak

These attractive shrubs will produce delicious sweet cherries even in problem shade areas! Masses of white blooms in May. Makes a fine specimen or grouped as hedging. Mature ht 3 m (10 ft). Self-pollinating. Standard Nanking Cherry, only younger stock. 25 cm (10 in) plants. Plant 60 cm (2 ft) apart.

Bundle of 10 A \$49.95; 25 for C \$105.95; 50 for G \$179.95

Growing your own fruit enables you to control what is applied to them during the growing process! Something that cannot be said for store bought fruit. All are an excellent addition to your "edible" landscape!

PEARS



Pears Require 2 Varieties For Pollination.

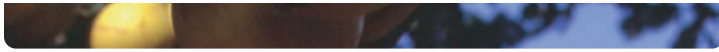

8045 Early Gold Pear

A seedling of 'Ure' with improved vigor and cold hardiness. Fruit is similar in taste to the Ure pear. Fruit size 5 cm (2 in). A hardy pear tree with clouds of showy white flowers in spring, good fall colour and consistent oval shape; small high quality golden fruit is excellent for fresh eating. Very resistant to fireblight. Mature size 7 m (25 ft).

1 Tree **A** \$48.95; 2 or more \$44.95 each



8044 Beedle Pear

This pear is zone 2 hardy, good producing, medium size pear comparable or better than Ure. Ripens on the tree in mid to late September with good storage keeping qualities. A sweet, soft and juicy pear. Mature size 6 m (20 ft).

Tree **A** \$48.95; 2 or more \$44.95 each



8055 Russian Beauty Pear (Krazulya)

A beauty from Russia! The most flavorful pear of the early ripening varieties! Fruit drips with sweetness when you bite into it—with a hint of spice! The attractive fruit is yellow with a bright red cheek. The flesh is juicy with a buttery texture and the shape is more round than the common pear. Fruit matures mid to late August and is at its peak when eaten or processed quickly. Mature size 10 meters (35 feet).

Each **A** \$48.95; 2 or more \$44.95

Manitoba residents: Fruit is not taxable.

PLUMS



8026 Patterson Plum

Introduced by the U of Saskatchewan in 1960, this plum has a unique weeping growth habit. The fruit is 4 to 5 cms in diameter, deep red with a slight waxy bloom. The flesh is firm, sweet and aromatic and the skin is thin and not sour. This cultivar ripens mid September. Much larger and sweeter than other hardy plums, excellent for fresh eating, baking, jams and drying. Needs wild plum to pollinate. Mature ht 2 m (7 ft). Prices below



8023 Pembina Plum

One of the most satisfactory varieties for the Prairies. Fruit size 5 cm (2 in) in diameter. Freestone. Dark red with heavy blueish bloom. Flesh is orange, juicy and sweet. One of the best large dessert plums. Lovely fall colour. Prairie standard since 1920! Excellent eating quality. Mature ht 5 m (15 ft).

Your Choice - Each 120 cm (4 ft) **A** \$51.95; 2 or more \$47.95 each

Plums are not self-pollinating, see pollination below.



8025 American Wild Plum

The American plum is used for both ornamental and culinary purposes. Ideal for jams and jellies. The long wand-like branches form a wide, graceful head which is handsome in winter and in spring. Covered with masses of pure white fragrant flowers followed by ample bright foliage and abundant showy globular fruits which are about 2.5 cm (1 in) in diameter. Mature height is 4.5 metres (15 ft) Excellent pollinator for all plums!

Each **A** \$8.75; 2 or more \$7.95 each

Pollinating Fruit Trees: usually plant two!

As a rule, unless otherwise indicated, you should plant two of any kind of tree or shrub for cross-pollination and abundant crops. Or it is sufficient if a neighbour has a similar kind. Note that Nanking Cherry, Sandcherry and Double Flowering Plum will cross with Plums.

FIG TREE



As these fig trees are not winter hardy under a Zone 5, it is advisable to grow it in a pot and bring it inside for the winter! Another plus for Figs, deer don't like them!

8000 Chicago Fig

This medium sized fig tree ripens to a delicious, very sweet, golf ball size figs with a medium skin that can be peeled and eaten fresh off the tree in late summer and early fall! This easy-to-grow and high yielding fig is also known as 'Bensonhurst Purple.' Its origins are from Sicily. Mature height can be up to 3.6 m (12 ft) tall and 3 m (10 ft) wide. Self pollinating.

Each **A** \$22.95, 2 or more for \$20.95 each

8002 Negrone Fig

A naturally small tree, Negrone fig trees bears striking, almost black fruit, with tasty, sweet, dark red flesh. Negrone is well suited for container culture or confined spaces. Size at Maturity: 1.8-2.4 m (6-8 ft) in height, can be smaller with pruning. Self pollinating.

8003 Fig Collection

1 each of the 2 above plants **A** \$40.50

ONCE A YEAR TREE FERTILIZER



3266 Once-A-Year High Acid Fertilizer 14-6-10 + 8% Sulphur*

A great new granular fertilizer for all fruit trees, ornamentals and acid loving trees! In colder climates one application in spring or early summer will do for a year. In warmer climates, (Southern Ontario, BC) can use 2 applications per year, spring and summer.

Provides a natural slow release deep root feeding that will keep trees and shrubs healthy and robust! Stimulates roots of injured plants from drought and dwindling nutrients! Easy to apply and just water in to activate!

2 kilos **A** \$32.95; 2 or more \$31.95 each.

FRUIT PICKERS DELIGHT!



3225 Fruit Picker Head*

This old-fashioned design will make your fruit harvest easy! Strong metal tongs to grasp fruit and pull into cushioned metal basket which catches the fruit. Will easily pick apples, peaches, apricots, plums, etc. Lightweight and easy to use. Head only, attaches to any garden handle.

Each **A** \$17.95; 2 or more \$16.95 each.

RED SPHERE TRAPS



3395 Red Sphere Traps*

Simple but effective traps will attract and trap damaging Apple Maggot flies! Flies are attracted to spheres when hung in your trees and are quickly trapped. Kit contains 3 red plastic spheres, 3 hangers, 225 gram (8 ounce) jar of Stickyfoot brush on formula and an application brush. Non toxic. Protect your Apple and Cherry crop the easy and safe way! **See page 71 for Stickyfoot refill.**

Each Kit **A** \$39.95

DWARF HARDY APPLES

- Hardy to zones 2 and 3
- Mature height & spread 2 - 3 metres (6 - 8 feet).
- Perfect for smaller yards.
- Fruit size is the same as on regular root stock!



7996 Odyssey

A hardy medium to large sized apple that is yellow-green, flushed with red;. An excellent, sweet dessert or cooking apple . The sweet flavour is comparable to 'Gala' apple, ripens in mid-September, and is a great storage apple!

Each 90 cm (3 ft) **A** \$58.95, 2 or more for \$54.95 each



7997 Goodland

One of the best Apples for colder regions. Flesh is crisp, juicy, tender and aromatic. Good storing, but best eaten fresh. Developed at the Morden Research Station. Ripens August.

Each 90 cm (3 ft) **A** \$58.95, 2 or more for \$54.95 each

Dwarf apples are included in apple special on page 93

*Due to their dwarf habit, these trees will bear earlier than regular apples.

HARDY APPLES



8010 Red Wonder

A red fleshed apple with a mild sweet taste. Both the skin and flesh are red. The fruit is also good for cooking, baking, freezing, drying and juice. An excellent all purpose apple. Tree is hardy to zone 3 and the apples are ready to eat in September. It's also a pretty tree, compared to the average apple tree, this one stands apart with it's silver tinged dark leaves. Mature ht 18ft. Each 90 cm (3 ft) **A** \$58.95 2 or more for \$54.95 each

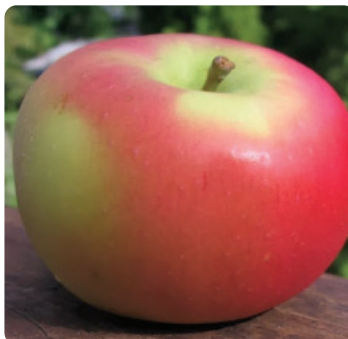

8004 Alberta Buff

Green/blush red apple. It is larger and later ripening than Norkent. It has a sharp, sweet flavour like Honeycrisp. It is consistently picked the best apple, for flavor at the Devonian gardens fall fruit festival in Alberta. It has excellent eating and keeping qualities. Hardy down to Zone 2 Each 90 cm (3 ft) **A** \$58.95, 2 or more for \$54.95 each

HARDY APPLES

Hardy to zones 2 and 3. Regular size trees (8005 to 8019). Mature height & spread 4 - 5 metres (12 - 15 feet)



8008 Apple Red Sparkle

Crisp and juicy, often described as a dessert apple. Green foliage, blooming with pink overtones in the flowers. A popular and hardy red apple that bears fruit in early fall. Great for fresh eating, cooking and baking. Requires cross pollination from another apple tree. Average height 6 m/19 ft.

Each 90 cm (3 ft) **A** \$58.95, 2 or more \$54.95



8005 Honeycrisp

This outstanding variety was developed out of the University of Minnesota. Incredible storage qualities, up to 7 months in trials. Excellent home variety due to its exceptional crisp and juicy flavour. Will ripen mid-September.

Each 90 cm (3 ft) **A** \$58.95, 2 or more \$54.95

8005 Honeycrisp



8012 Norkent

Derived from a Haralson and Rescue cross. It produces a large fruit with a very pleasant apple/pear taste and is often compared to the variety Golden Delicious. Ripens late August. Very hardy and stores well.

Each 90 cm (3 ft) **A** \$58.95, 2 or more \$54.95

T&T Super Apple Special

All our apple trees are included in this special! Mix n' Match **2 or more, your choice \$54.95**

This page and also includes 8004, 8010 & 7980 Treasure Red (Back cover). 7980 to 8017 - \$54.95 each



8019 Valentine

We feel that this variety will quickly become one of the most popular apples on the prairies! A juicy large apple that was selected by Bert Porter of Honeywood Nursery of Parkside Saskatchewan. Bert was a prolific breeder who found world fame with his lilies and was passionate about hardy fruit trees. Lost for many years, it was found by Jim Coult's of the Scott Experimental farm in Unity Saskatchewan. It is one of the largest fruited sorts, bearing fruit that is yellow-green with a red cheek, often exceeding commercial McIntosh apples in size. It ripens in late September and is a good dual purpose

variety, and keeps well under refrigeration. Fabulous in pies and excellent fresh eating.

Each 90 cm (3 ft) **A** \$58.95, 2 or more \$54.95

8018 Zestar

Finally, an early season apple with a crisp, juicy texture, and an exciting zesty flavor with a hint of brown sugar! Can usually be picked in late August/early September. Unlike many early varieties it is a notably crisp apple and can be stored for at least a month in the fridge. Excellent for fresh eating and cooking.

Each 90 cm (3 ft) **A** \$58.95, 2 or more \$54.95



8014 Kerr Crab Apple

Tree is a unique cross of Dolgo crabapple and Haralson apple which bears large, flavorful, crisp and juicy, dark red fruit. Very hardy (to minus 45C/50F), productive and disease resistant. The fruit is great for fresh eating and makes tasty jelly.

Each 90 cm (3 ft) **A** \$58.95, 2 or more \$54.95

Produce Larger Apples!

You may be surprised how much bigger your Apples (or other fruit) will be when you give them healthy doses of fertilizer and chelated iron (mainly on Prairies). Fertilize all summer along the drip line with 15-15-30 (see p. 64) Turkey Trot (see p. 65) and iron product (see p. 69).

Note: Plant 2 trees of the same or different varieties for best apple pollination. May be planted as much as 50 m (150 ft) apart.

Fruit trees prefer soil on the acidic side (between 5.5-7.0)

Note that fruit trees, shrubs and canes will perform better if soil is at least slightly on the acidic side. If you notice leaves of apple trees, raspberries, grapes, etc. beginning to yellow, treat with acid-enhancing sulphur on p. 65.

GRAPES



8035 Valiant

A cold hardy blue grape with a sweet, rich, tangy flavour. Ripening the third week in August, this outstanding blue grape produces a large crop for making into wine, juice, jams and jellies, baked goods—or just eating fresh!

Each **A** \$22.95; 2 or more \$20.95 each

8036 Louis Swenson

~~Produces clusters of round, medium-sized grapes that turn yellow-gold when ripe. It has naturally low sugar with moderate acidity, wines created with this grape are light-bodied with a delicate aroma of honey and flowers.~~

CLICK TO SEE REPLACEMENT

8038 Marquette

A cousin of Frontenac and grandson of Pinot Noir, this grape is rapidly becoming the most popular northern red grape variety. An early-ripening, high-yielding grape that abounds with small to midsize berries. Cold-hardy and disease-resistant. Developed at the University of Minnesota.

8039 Frontenac

An excellent red wine grape released from the University of Minnesota! The vine's best advantage is its' extremely vigorous and productive nature. Very resistant to disease, with good resistance to Powdery Mildew. High sugar levels, along with high acidity, are typical at harvest.

Grapes will produce fruit with one plant, but for best production plant two! Good rule of thumb is one plant every 2.4 m (8 ft).



Dual Purpose - Screening & Fruit!

Grapes have good vigour to cover a trellis rapidly with thick foliage, perfect for adding some green to a home landscape. Grapes many laterals can easily and quickly spread over a fence, wall trellis, pergola, etc.

8034 Manitoba Native

Hardy vine ideal for fence or trellis. Will give a robust, quick cover. The fruit is small but will make tasty jelly and also excellent wine. Vigorous grower with fragrant flowers - will also tolerate some shade. 2 year plants.

1 package (2 roots) **A** \$26.95



Feature Grapes



8042 Grape Sommerset (Seedless)

The hardiest seedless grape for Northern gardens. This heavy bearer will give you very compact clusters of medium-sized sweet, pink blushed grapes that are good for fresh eating and making jelly! The grapes are tasty once they turn pink but if left to ripen further, the pink turns to red and they will become sweeter and more flavourful! Vines grow 1.2-1.8 m (4-6 ft) tall with a 60 cm (2 ft) spread. This variety is self-fertile but planting more than one type will improve your harvest. Ripens in August.

Each **A** \$25.25; 2 or more this variety \$22.95 each



8037 Emerald Ice Grape

A wine grape with massive clusters of large, bright green grapes. Not only is the fruit large, but it also has a high sugar content as well. Great variety to eat fresh off the vine or process into wines, jam, and jellies. A great prairie hardy variety from a breeding program in southern Manitoba.

Each **A** \$26.95; 2 or more this variety \$24.95 each

ORGANIC FERTILIZER



3289 Evolve Rage Plus*

Made with only organic ingredients derived from kelp (fresh water seaweed) and natural micro-nutrients. Evolve Rage Plus organic fertilizer increases your plant's metabolism and acts like a steroid for your plant. Whether your plant is trying to produce leaves, flower, fruit or storing sugars into its root zone to survive the winter, this organic fertilizer is the fuel your plant needs!

Corrects many nutrient deficiency symptoms quickly and revives struggling indoor and outdoor plants fast! Winter kill on plants? Give your plants a jump-start with Rage Plus. **Concentrated product makes 333 Litres (73 Gal) of fertilizer-very economical.** Can be used on all plants both indoors and outdoors!

1 litre **A** \$29.95; 2 or more \$27.95 each

Dormant stock 101

For more information about our dormant stock, check out page 4.

Manitoba residents: Fruit is not taxable

KIWI

Attractive Leaves!



Fruit grows just like grapes. The decorative vines are covered with lovely white flowers in spring, with a fragrance similar to Lily-of-the-Valley. The fruit is smooth skinned and therefore does not require peeling. The fruit averages 5 cm (2 in) in size. Plants should be spaced at least 2 m (6 ft) apart.

8093 Chung Bai Kiwi
Single female plant A \$12.95

8094 Meader
A productive male variety which produces large volumes of flowers A \$12.95

8095 Arctic Kiwi Collection
1 collection A \$34.50

Collection consists of three plants: 2 females and 1 male, to ensure proper pollination.

SANDCHERRY



Can Grow 6 Feet In 2 Years!



8070 Sandcherry Windbreak
A dual purpose shrub. Foliage is an attractive silver-purple colour. It also will produce an excellent black fruit for preserving and wine. Mature ht 2 m (6 ft). 30 cm (12 in) plants. Plant 60 cm (2 ft) apart.

Bundle of 10 **A** \$38.95; 25 for **C** \$86.95; 50 for **G** \$164.95; 5 for **F** \$21.65

ARONIA



Fantastic Fall Colour



8155 Viking Aronia

Viking is the most productive cultivar of the aronia, yielding as high as 5 tons per acre. This easy-to-grow native plant is loaded with black berries that ripen in late summer and can hang on the bush throughout winter. Berries are very high in antioxidants and are great used for wine, juices, jam, baking and more. Highly ornamental shrub features fragrant, white blooms and glossy green foliage. Grows 1.5 m (5 ft) in full sun to partial shade.

Each **A** \$16.95; Bundle of 3 **B** \$40.95; Bundle of 6 for **C** \$70

The Aronia berry has been dubbed one of nature's "superberries" because of its extraordinary nutritional value.

They are similar in size to blueberries and a deep violet in colour. The health benefits are based on its very high levels of anthocyanins and flavonoids. Three times the antioxidants of blueberries and five to ten times higher than cranberries, with beneficial nutrients such as antioxidants, polyphenols, minerals and vitamins.

A reliable prairie shrub that is excellent at holding soil in place and preventing erosion, which makes it a good selection for hillside plantings in any type of soil.

Due to the increasing interest in aronia's health benefits, many commercial growers are adding this to their fruit operations for profit, too!

RHUBARB



8089 German Wine

Large stalks are dark red and very sweet. Great for eating raw or for baking and canning purposes. One of the most vigorous varieties where the second harvest in the same season is the highest; stalks are easy to pull.

Each **A** \$18.95; 2 or more \$16.95 ea.



8161 Arctic Raspberry

Nagoonberry is a small herb that only grows 3-7" tall. It has an erect stem with one solitary 1" flower that has 5-8 long, light pink, narrow petals. The leaves are 3-parted and coarsely veined.

One of each variety for proper pollination "Anne" and "Valentina"

Each pack of 2 **A** \$29.95; 2 packs or more \$26.95 each.

WOLFBERRY



Amazing Fruit Production!

8040 Phoenix Tears Goji Berry (Lyceum barbarum)

Not only a vitamin-packed, mineral-rich, sweet berry for eating out of hand. But young leaves and shoots can be added to stir-fries and berries to soups and other dishes. Attractive, multi-stemmed shrub grows to 5 to 6 feet tall and 5 feet wide. Arching branches are loaded with deep orange 2 cm (3/4 in) long, narrow berries with carotene levels higher than found in carrots.

Each **A** \$13.95; 2 or more \$11.95 each.



8092 Valentine

Sweet, low-acid stalks that are perfect for zesty sauces and pies without needing as much sugar. Serve over ice cream, combine with fresh strawberries, or made into pies, tarts, puddings, breads, muffins, cakes, jam, jellies, and refreshing beverages. Rhubarb provides vitamins C and K, calcium, potassium and fiber. A vigorous variety with high yields.

Each **A** \$18.95; 2 or more \$16.95 each.

BLUEBERRIES



Rich In Antioxidants!



Low Bush

A hardy cross between a wild low-bush and a commercial high bush blueberry. The fruit is about double the size of wild blueberries. Ripen mid-July. The bushy plants will grow to 60 cm (2 ft). Approx. yield 2 kg (5 lbs) per mature plant.

8030 Northblue

Fruit is dark blue, large and sweet. Good storage variety with refrigeration. Excellent for landscape as foliage is vigorous and a rich dark green.

8032 Chippewa

Berries are sweet and light blue in colour with an intense flavour! Fruit size is medium on 90 cm (3 ft) plants that have a slightly spreading habit.

Prices for above low or high bush blueberries
1 plant **A** \$18.95; 2 or more plants \$16.95 each

8029 High Bush Collection - 1 of each 8024 & 8028.

8033 Low Bush Collection - 1 of each 8030 & 8032.

Each collection price, (2 plants per collection) **A** \$31.90

High Bush

A hardy cross between a wild low-bush and a commercial high bush blueberry. Well branched and ripen mid-July. Mature plants will reach 1.3 m (4 ft).

8024 Blue Gold

Medium sized berries with outstanding flavour and heavy fruiting habit! This bush will yield 3.5-5.4 kg (8-12 lbs) of berries per year. Fruit maintains good quality for up to 5 weeks in storage!

8028 Northland

Vigorous, heaviest producer--7 kg (15 lbs) per mature plant. Fruit size is smaller but easy to harvest as it is borne on long and loose clusters! Rich, wild berry flavour.



8078 Chester Blackberry (Thornless)

Huge arching canes and astonishingly large, deep black, very sweet berries. Ideal eaten fresh or made into preserves and blackberry wine or just frozen for later use. Very vigorous vine, growing 2-3 m (6 to 9 ft) easily, so space is essential! Fruit starts to mature in late August and continues for several weeks. Grow Chester up a trellis or along a fence where the self-supporting stems will hold themselves up and offer you their rich pickings!

2 canes for **A** \$27.95,
4 canes for **B** \$52.95

RASPBERRIES



Customer Favourite!

8073 Boyne (Regular Cane)

Longtime reliable favourite! Succulent, large, dark-red fruit. Heavy cropper. Firm berries, easy to pick and carry. Strong, sturdy canes.

5 for **A** \$25.95; 10 for **B** \$48.95;
30 for **C** \$140.95; 100 for **D** \$360.00



Sweet As Honey!



8074 Honey Queen (Regular Cane)

One of the hardiest yellow Raspberries available. Produces large, sweet as honey berries, which are excellent for jams or eating fresh. This is definitely a "gourmet" variety! Will also grow in **light shade**.

5 for **A** \$25.95; 10 for **B** \$48.95; 30 for **C** \$140.95



Easy To Maintain!



8075 Red River (Primal Cane)

A release from Morden Research Station. An early everbearing variety. Produces loads of large fruit. Responds well to complete cane removal in spring for optimum production in late summer.

5 for **A** \$24.95; 10 for **C** \$46.95; 30 for **D** \$134.95



Earlier To Fruit!

8071 Pathfinder (Primal Cane)

A very productive variety with relatively short, spiny canes with very good suckering. Fruit is medium to large with very good firmness, medium red colour and good flavour. Earlier than Red River!

5 for **A** \$24.95; 10 for **B** \$46.95; 30 for **C** \$134.95



Thornless!



8076 Nova (Regular Cane)

Released from the Nova Scotia, Canada, Breeding Program in 1981. Berries are firm, bright-red, medium to large in size, ripen gradually over a long harvest season, and have a good shelf life.

5 for **A** \$24.95; 10 for **B** \$46.95; 95 for **C** \$134.95

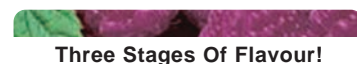

Three Stages Of Flavour!



8077 Royalty Purple (Regular Cane)

A unique purple Raspberry that has large berries at the red stage with the traditional flavour! Later, at its purple stage, the flavour is stronger and sweeter. At the over-ripe stage, it has a flavour close to that of a black Raspberry!

5 for **A** \$24.95; 10 for **B** \$46.95; 30 for **C** \$134.95

Regular Cane

Produces berries on last year's growth.

Primal Cane

Cut them right to the ground in spring. They still produce a full crop that summer.

See planting guide for raspberries on page 97

BLACK RASPBERRY



Clusters Of Deep Purple Heart-Shaped Berries With Black Overtones



8180 Wyoming Black Raspberry

Wyoming produces a unique black raspberry with a lovely aroma and a raspberry/blackberry flavour! It features an abundance of magnificent black berries from mid summer to early fall--with canes reaching up to 2m. Canes must be supported if they are heavily laden with fruit. Ideal for fresh eating, jams, jellies, cooking and baking. A self-pollinating variety, so it doesn't require a second plant nearby to set fruit. Non-suckering canes, makes this a popular choice if your space is limited.

2 for **A** \$23.95; 4 for **B** \$42.95

STRAWBERRIES



Great In Containers Too!



7503 Kent (June bearing)

The biggest selling June bearing strawberry in Canada. Sets the standard for high yields. Very vigorous, abundant runners, with a short harvest season.

7509 Fort Laramie (Everbearing)

One of the sweetest everbearers. Extremely hardy, heavy-bearing with excellent vigor and heavy runner production. Berries are large and bright scarlet red in colour.

Strawberry prices

7503 to 7515, individual varieties

10 plants	A	\$20.65
25 plants	B	\$31.95
50 plants	C	\$57.95
100 plants	D	\$98.95
500 plants	E	\$375.00
1,000 plants	F	\$525.00



Good Trailers Or Climbers!



7510 Strawberry - Patch Collection

10 Kent; 10 Fort Laramie; 10 Seascape; 30 labeled plants **A** \$44.45; 2 or more coll. \$39.95 each

7515 Seascape (Day-Neutral)

Day neutral strawberries that will set fruit early (on both mother plant and runners) and continues right into fall. Retains its flavour and shape better than other strawberries when frozen.

PINE BERRIES



Pineapple-Like Flavour!



7530 Pineberry

The name "pineberry" is a fusion of the words "pineapple" and "strawberry" and refers to a relatively new pale pink to white strawberry cultivar that is adorned with red seeds. The fruit is very aromatic and the flavour is reminiscent of pineapple while retaining the texture and feel of a strawberry.

5 plants **A** \$13.75; 10 plants

B \$22.95; 25 plants **C** \$42.50; 50 plants **D** \$68.95

THIMBLEBERRY



Similar To Raspberries - But No Thorns!



8072 Thimbleberry

The vigorous plants grow to a height of .9-1.5 m (3-5 ft) with smooth stems. The plants produce pure white flowers on 2 year canes... a spectacular show in the spring! Fruits are sweet and juicy with some tartness, great for fresh eating or use in juice and jams. The leaves are quite large, approximately 10-15 cm (4-6 in) long and wide and is a spectacular lime green in the summer, changing to bright yellow in the autumn--making this an outstanding landscape plant also!

2 canes for **A** \$20.95, 4 canes for **B** \$37.95; 6 canes for **C** \$53.95

APPROXIMATE PLANTING GUIDE

Strawberries			Raspberries		
Row Spacing in M/Ft	Row Spacing in M/Ft	Plants per 30 M/100 F	Row Spacing in M/Ft	Plant Spacing in CM/Ft	Plants per 30 M/100 Ft
.91 m or 3 ft	50 cm or 20 in	60	1.8 m or 6 ft	45 cm or 18 in	66
.91 m or 3 ft	60 cm or 24 in	50			

CHOKECHERRY

Heavy Producer!



8066 Robert Chokecherry

An outstanding release from Barrhead, Alberta. Developed by Lloyd Lee, this incredibly heavy yielder has fruit the size of grapes. Foliage is a rich red like Schubert trees and has a mature height of 3 m (10 ft). Ideal as a feature tree. Use fruit to make excellent wine, jams, jellies, and fresh eating.

2 for **A** \$28.95, 4 for **B** \$51.95; 6 for **C** \$70.95

SASKATOON

Large, Sweet Berries!



8050 Smokey Saskatoon

A popular commercial variety - as fruit will ripen all at the same time! The berries are exceptionally large and have a sweet flavour. Excellent for fresh eating, jams and desserts. Also used as an ornamental shrub with great fall colour. Mature height 3 m (9 ft).

Each 30 cm (12 in) **A** \$24.95; 2 or more \$21.95 each

8065 Smokey Seedlings

Same as above just smaller seedling -size stock. A more economical way to start your own orchard or fruit collection. 20 cm (8 in) plants.

Bundle of 5 **A** \$46.95; 10 for **B** \$89.95; 25 for **C** \$199.95; 50 for **G** \$360.00

HAZELBERT

Gorgeous Fall Colour!



8048 Hazelbert

Specially bred for our northern climate, this trees parent was out of Skinners Nursery in Dropmore, Manitoba. Small in size but very big in production, these nicely shaped trees yield enormous crops of easy-to-crack nuts in a hurry. Also known as "Filberts". Need 2 for proper pollination. Mature height 3 m (9 ft).

Each 90 cm (3 ft) **A** \$33.95;
2 or more \$31.50 each

CRANBERRY

High In Vitamin C



8069 Highbush Cranberry

White flowers in June, followed by large clusters of brilliant red fruit in the fall. Fruit is excellent for jams, jellies or juice. In the autumn it puts on a brilliant display with its vivid red foliage. While it is technically self-pollinating, this shrub tends to set more fruit with a second tree nearby. Mature ht 2.5 m (8 ft). Plants 40 cm (16 in).

Each **A** \$14.95; 2 or more \$12.95 ea

Fruit & Berry Booster



3389 Fruit & Berry 3-2-4*

100% organic plant food specially formulated for fruit trees, strawberries, raspberries, blueberries, etc. Produces high quality fruits, with good taste and long shelf life! Highly concentrated 2 to 4 tsp per litre of water and apply every 7 to 10 days! Gardeners have seen the results in increased berry size and flavour!

870 ml concentrate **A** \$21.95;
2 or more \$19.95 each

THE RULE OF TWO

Plant two of any kind of tree or shrub for cross pollination and abundant crops.



**HAVE A QUESTION?
We Can Help!**

send us an email
garden@ttseeds.com

HASKAP HONEYSUCKLE



We are pleased to offer two varieties of haskap edible honeysuckles. These honeysuckles are extremely hardy and early fruiting. The flower is hardy to -8c and the fruit is ready to harvest the third week of June. The fruit taste has been described as a combination of blueberries and raspberries and with a "melt in the mouth" texture! Produce a very small seed that is not noticeable when eating. Haskap is becoming a commercial crop but is ideal for the home gardener too! A naturally low shrub, 1.5 to 2 m (4 to 6 ft) - should require relatively low maintenance. These improved strains have been developed by the University of Saskatchewan.

Beauty & Blizzard will pollinate each other

8102 Boreal Beauty Haskap

These exciting new haskaps have bigger berries, bigger plants, all with great flavour. They extend the season, with harvest ranging from early July into mid August. Mature height 1.2-1.5 (4-5 ft.) Approximately 25 cm (10 in) plants at shipping.

8105 Boreal Blizzard Haskap

One of the first larger berried varieties set to completely change the haskap industry. This variety is an ideal choice for U-picks and for the home gardener. Approximately 25 cm (10 in) plants at shipping.

Pricing for above honeysuckles

(one named variety only per package size):

Pkt. 2 plus pollinator - (3 plants total)	A	\$47.95
Pkt. 6 plus pollinator - (7 plants total)	B	\$89.95
Pkt. 12 plus 2 pollinators - (14 plants total)	C	\$165.95
Pkt. 24 plus 4 pollinators - (28 plants total)	D	\$315.00

8100 Haskap Collection

One each of Blizzard and Beauty. Collection (2 plants) **A** \$29.95

Perishable Stock

We purchase our perishable stock from all over the world. All the stock is shipped into our Headingley warehouse to be packed and stored at controlled temperatures. This ensures that the stock is kept dormant and fresh. We buy stock that is hardy to zones 2 and 3. If they are not, we state this in the description. Our warranty policy does not allow for claims to be made on plants before 6 weeks or after 90 days. Please ensure that you are following the guidelines in order to successfully make a warranty claim. Upon arrival of your order, make sure you open and inspect it immediately to ensure that your order is correct and that nothing has been damaged. If it has been, notify us immediately so we can correct it.

Manitoba residents: Fruit is not taxable.

SEA BUCKTHORN

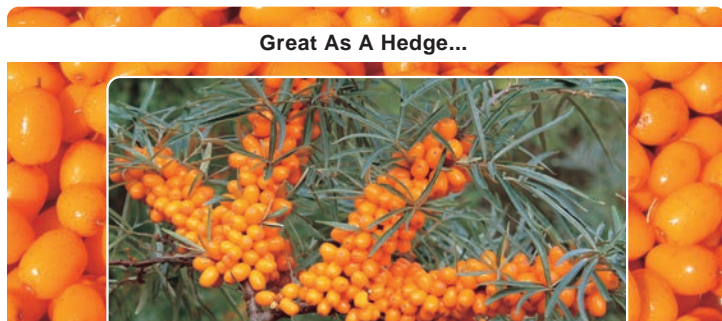

Great As A Hedge...

Plus Great Fruit Production!

8400 Sea Buckthorn

This versatile shrub makes an excellent hedge, but will also provide you with an incredibly nutritious fruit as well! Rich in omega 3, 6, 7 & 9, vitamins a, c, e & flavinoids. Drought resistant and tolerant to alkali soils! 4 females, 1 male. Mature ht 3 m (9 ft), spreads 2 to 3 m (6 to 9 ft).

Bundle of 5 plants **A** \$64.95; 2 or more bundles \$61.95 each

ELDERBERRY



8079 Ranch Elderberry

Hardy, productive plants are adaptable and can perform in many types of soils. Fruit is great for pies, wines and jelly. This variety has been selected for it's compact habit that thrives in urban environments. Fruit ripens in late summer. Elderberries have been a natural remedy for centuries. Sold in bundle of 2 (1 Ranch & 1 Wild) to ensure proper pollination. Ht 1.8-2.4 m (6-8 ft).

Bundle of 2 for **A** \$30.95; 2 or more bundles for \$27.95 each

CURRENTS



8 Times The Vitamin C Of An Orange!



8082 Ben Nevis Currant

Ideal for jams and jellies. Large black fruit with a strong flavour. New mildew resistant variety. Out yields all others! Currants attract birds & biodiversity to your garden. Mature ht 1.2 m (4ft), spreads .9 m (3 ft).

Each 40 cm (16 in) **A** \$16.95; 2 or more \$14.95 each

8084 Red Lake Currant

Produces large crops of dark red fruit. The berries grow on compact mounding deciduous shrubs. Perfect in any edible or ornamentals landscape. Used for desserts, preserves or wines. Rich in fibre. Mature ht 1.2 m (4ft), spreads 1.2 m (4 ft).

8080 Currant Collection

One each of the above, 2 plants **A** \$27.50

ASPARAGUS

All asparagus are 2 year plants. Dig a trench for planting instead of a hole for best results!

Feature Asparagus



8125 Sweet Purple

Excellent producer with spears a little on the thicker side. This newer variety not only has an attractive shade to it, but it also has such a mild sweet flavour that is often eaten raw! This would be a must for all your dinner parties!

5 for **A** \$18.95; 10 for **B** \$32.95; 25 for **C** \$64.95; 50 for **D** \$120.00



8090 Mary Washington

A spring delicacy, these plants grow rapidly, producing exceedingly tender stalks of excellent flavour.

10 for **A** \$17.95; 25 for **B** \$37.95; 50 for **C** \$65.95; 100 for **D** \$125.00



8091 Jersey Knight

A strong male hybrid that will yield 3-4 times more spears than other varieties. Excellent flavour.

5 for **A** \$17.20; 10 for **B** \$29.85; 25 for **C** \$60.90; 50 for **D** \$104.50; 100 for **E** \$165.00

GOOSEBERRY

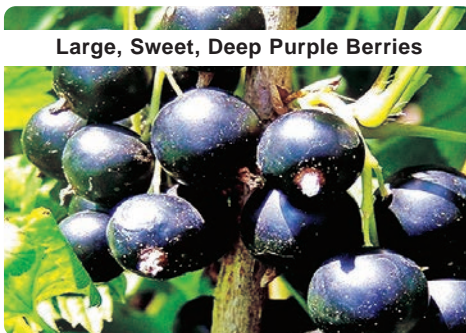

Large, Sweet, Deep Purple Berries

8081 Black Velvet

Vigorous, very productive bush producing dark purplish-black berries, tastes like most other gooseberries: sweet with a slight tartness and very fruity flavour! High in Vitamin C. Excellent for eating fresh, juices, wines, jellies, preserves or pies. Mature height 1.2 m (4 ft).

Each 30 cm (12 in) **A** \$20.95; 2 or more \$17.95 each



Almost Thornless



8083 Pixwell

A virtually thornless selection of gooseberry for the home orchard that produces abundant green fruit that develop a red-pink blush when ripe, sweet flesh and a tangy skin; This is a self pollinating variety, so it doesn't require a second plant nearby to set fruit. Mature height 1.2 m (4 ft).

Each 30 cm (12 in) **A** \$20.95; 2 or more \$17.95 each



High Yielding



8086 Jahn's Prairie

Produces large red berries which are great for baking or in jellies. The plants are mildew resistant, productive and very vigorous. Sweet flavour with a hint of apricot taste! Mature height 1.2 m (4 ft).

Each 30 cm (12 in) **A** \$20.95; 2 or more \$17.95 each

8085 Black Velvet Collection

1 Collection (3 plants) **A** \$49.95

LINGONBERRY

What is a Lingonberry?

They are small, red, edible berries that grow on a perennial, woody, evergreen shrub with a low growth habit. They are related to both blueberries and cranberries and have a tangy-tart taste, and have been used for centuries both as food and as medicine. Berries can be eaten raw or can be processed into jam, juice or syrup. Contains extremely high amounts of quercetin, a flavonoid with strong anti-inflammatory properties, and can be used as a natural remedy for the pain and inflammation associated with rheumatoid arthritis. Two or more cultivars are recommended for optimum pollination.



Native To Sweden

8087 Red Sunset

Medium-to-large firm berries. Bright red glossy fruits are tart until ripe, then has excellent flavour, richer and less astringent than cranberries. Considered one of the most vigorous cultivars of lingonberries. Mature ht 30 cm (12 in) tall.

Each **A** \$16.95; 2 or more \$15.95 each



Taller - More Productive!

8188 Erntesegen

The German name means harvest blessing. A very vigorous plant with large dark green leaves, growing 40 cm (16 in) tall and spreading. Very productive; berries are large, late ripening and crimson red.

Each **A** \$16.95; 2 or more \$15.95 each

8190 Sunset Collection

1 Collection (2 plants) **A** \$29.95

DID YOU KNOW?

The soil for good blueberry culture should be modified toward high acidity (pH 5.5-6.5). A heavy annual application of spruce or pine needle mulch will accomplish this. If a more radical acidification is needed, Garden Sulfur (p.65) can do the trick. Take time to test the pH of your soil; blueberry plants will be sickly if the soil is not acidic enough. To protect fruit and plants during fruiting and ripening season, try Bird d-Fence to fend off unwanted birds and other airborne pests.

SWEET POTATO

Grown Locally In Manitoba & Spray Free!



9100 Covington Sweet Potato

An improved early variety suited for short northern growing seasons with bright orange flesh and deep rose skin. Covington is a variety with sweet and smooth textured flesh great for roasting and mashing. Grown in house and shipped as rooted slips, these sweet potatoes are easy to transplant into your garden once we ship them to you in spring.

Sweet potatoes have a growth habit like a morning glory with trumpet shaped flowers and vining habit spreading up to 1.2 m (4') from the main stem, except they do not climb but form adventitious (secondary) buds to support further root and tuber development.

Thrives in raised garden beds, containers and hilled gardens, like potatoes.

5 plants **A** \$27.95; 10 plants **B** \$50.95; 20 plants **C** \$92.95; 40 plants **D** \$180.00; 100 plants **E** \$400.00

MULBERRY TREE



Sweet-tart Flavour!



8182 Trader Mulberry

An absolutely beautiful tree that can be grown as a single trunk or multi-stemmed shrub. Big, glossy black fruit are present throughout the summer. It will be hard to resist grabbing a handful to eat fresh or to use them in desserts, drinks, or for easy freezing. They are excellent for processing to make wine, fruit juice or jam. They can also be dried and eaten as a snack. The black berries are 1 1/2" long, juicy, and tart like a wild blackberry and they have a distinctive aroma. Will ship in a 2.5" (6cm) pot.

Each **A** \$20.95 each

SUNCHOKES



Sweet & Nutty Flavour!



9030 Jerusalem Artichoke (Sunchoke)

This 'Sunflower' produces knobbly, white-fleshed tubers you can eat both raw and cooked. A much under-rated vegetable which has edible tubers that have a potato-like texture and are delicious. Also known as Sunchoke, they produce a mass of bright yellow sunflower-like flowers from July through to a heavy frost. They are often referred to as the "Potatoes of Canada"

1 pack (10 tubers) **A** \$21.95;
2 or more packs \$20.95 each

JOSTABERRY



Rich In Antioxidants!



8088 Jostaberry

A gooseberry and currant cross! The rich berry taste is reminiscent of gooseberry with a kiss of black currant. Cold-hardy plants are long-lived, thornless, and productive once established. The almost-black fruit is high in vitamin C and forms in large clusters. Ideal for juices, jams and jellies, and fresh-eating. Self-pollinating. Mature height 1-2 m (ft).

Each **A** \$20.95; 2 or more \$18.95 each

WHITE GARLIC



9025 White Garlic

Raise your own garlic for adding flavour to your pickles, salads and sauces. Easy to grow and store. Mild flavour.

6 bulbs per bag **A** \$13.95;
1 kilo (2.2 lb) bag **B** \$23.95

HORSERADISH



9033 Horseradish

A long, tapering root used as a condiment in kitchens. The root has a strong, hot, and sharp flavour, which can only be described after experiencing its unique taste! The roots are harvested in late fall and then peeled and ground before being enjoyed as a peppery condiment.

Package of 2 roots **A** \$11.95; 2 bags or more \$10.95 each

POTATO PLANTERS



3825 Potato Tubs*

Made from polypropylene, the Potato Tubs are of a strong stitched construction and come complete with carry handles to move them around easily for the crop to take advantage of the most favourable conditions. Clever opening flap at the base to allow access to the potatoes, so that they can be harvested when ready and as they are needed without having to pull out the whole plant. Measures 40 cm (16 in) diameter by 50 cm (20 in) tall, with drainage holes built in the base. Two large tubs per pack.

1 Pack (2 tubs) **A** \$34.95;
2 or more packs \$29.95

SOIL BOOSTER



3175 Sky Rocket Soil Enhancer*

All natural soil enhancer. Helps to balance the soil so plants can jump out of the ground, healthier and happier and grow with less disease and insect problems. Just a handful under each plant or tuber and watch them explode! Potatoes have less scab and insects. Tomatoes, peppers, glads, dahlias...any plants growth will be enhanced! All natural product contains a blend of Kelp, Worm Gold, Activated Charcoal and Betonite Clay. Excellent for houseplants too!

1 kilo **A** \$15.75; 5 kilo **B** \$39.95; Sampler 250 grams **E** \$5.50



Fertilize Potatoes For Maximum Yield!



3268 Super Spud Fertilizer 14-35-15*

The perfect fertilizer for short season growing, Super Spud combines important nutrients for even setting and tuber development of uniform potatoes. Rich in potassium and phosphate, giving excellent tasting and solid all-round keeping potatoes. Completely water soluble with important trace elements, good for all types of potatoes and soils. Easily applied through watering can or hose end sprayer.

454 grams **A** \$17.20; 2 kilo **B** \$45.95; 11 kilo **C** \$175.00



SEED



9040 Gold Rush



9036 Viking



9075 Butterball



9045 Dakota Pearl



9060 Kennebec



9094 French Fingerling



9090 Purple Caribe

POTATOES

Using certified seed potatoes will result in high quality and high yields in your potato patch.

GOURMET BLEND

9000 Gourmet Blend Sampler - A blend of our customer favorites, Viking, Bellanita and Gold Rush.

EARLY TYPE (65 + DAYS)

9048 Alta Blush - Reddish-brown skin with white tuber flesh! Excellent for mashing, baking and roasting. Yields well in a variety of soil conditions. Developed by John Safroniuk of Wetaskiwin, AB.

9055 Dark Red Norland - A standby favourite. Plant every two weeks for season-long mouth-watering baby potatoes.

9085 Bellanita - small-sized salad variety producing very high tuber numbers. Consistent in shape with attractive yellow skin and pale yellow flesh. Fingerling type. Closer planting will result in baby creamer potatoes.

MID TYPE (80 + DAYS)

9035 Roko - Oval potatoes with bright red skin and white flesh. Roko has a unique quality of producing high yields with uniform potatoes. Also excellent for winter storage!

9040 Gold Rush (Netted Gem) - High yielding variety; tubers are usually smooth and quite uniform. Excellent for baking and boiling; very good for French fries. Very white flesh, texture and excellent flavour make it perfect for your table!

9045 Dakota Pearl - One of the best uses for this potato is making chips. It has a pale yellow skin and white flesh with a good resistance to scab. A great storage potato.

9075 German Butterball - Oblong tuber with lightly netted golden skin and butter yellow flesh. This beauty is superb for everything – hash browns, fries, steaming or baking and it stores well. Excellent flavour.

9080 Yukon Gold - Excellent yield of yellow-fleshed tubers on small plants. Produces exceptional salads (be sure to add fresh dill!)

9036 Viking - Released in North Dakota in 1963 so you know it loves the prairies and tolerates drought. Smooth red skin, white flesh, good yields!

9090 Purple Caribe - What a masher and it doesn't seem to care where or how it grows! Sets and sizes up tubers quickly. Satiny blue-purple skin; whiter-than-white flesh.

9092 Violet Queen - Not just a curiosity anymore--a mainstream must! Deep blue skin with consistently blue flesh and excellent, rich flavour. Scab and tuber blight resistant.

LATE TYPE (90 + DAYS)

9065 Pontiac - Reliable, producing big tasty tubers and big yields even in clay and mucky soils. Thin reddish skin, crisp white flesh.

9060 Kennebec - Old reliable! Large, smooth, white-skinned, white-fleshed with shallow eyes for easy washing and peeling. Resistant to mosaic, late blight and net necrosis. Good keeper.

9094 French Fingerling - Oblong tubers with a red skin and light yellow flesh. It has the waxy texture characteristic of most fingerling varieties. It grows well and sets fairly heavy.

MB residents: this page is not taxable

ONION SETS



9055 Dark Red Norland



9048 Alta Blush



9035 Roko



9080 Yukon Gold



9065 Pontiac



9092 Violet Queen

Prices for all of the above potatoes:

A \$10.50; 2 or more bags your choice \$8.95 each

Packed by weight, you should plant approximately 10-20 hills per bag, after cutting larger potatoes.

Please Note: 10 kilo limit--anything over, extra postage will be applied, amount depending on province

PLEASE NOTE SHIPPING CHARGES

Everything on this page is perishable. Therefore, it is not shipped until planting time in early spring. Be sure to add the proper shipping charge on your order form.



9085 Bellanita

9005 Dutch Onion Sets

The first spring planting gives you early, fresh green onions. Left in the ground all season, they produce larger onions for winter storage.

100 bulb bag **A** \$3.95

9006 Red Onion Sets

Mild and sweet, dark red skin with pinkish white flesh.

100 bulb bag **A** \$3.95

9009 White Onion Sets

Mild white cooking onion. Excellent as green onions also.

100 bulb bag **A** \$3.95

9010 Spanish Type Sets

Similar to Dutch Sets, but will produce larger and sweeter spanish type onions.

100 bulb bag **A** \$3.95

9015 Multiplier Onions

Each bulb will produce six to eight mild-flavoured green bunching onions.

1 bag 15 bulbs **A** \$3.95

9020 Gourmet Shallots

A cross between garlic and onions. Mild gourmet flavour.

1 bag 12 bulbs **A** \$3.95

Special Mix 'N Match Onion Prices

3 or more bags your choice from 9005 to 9020 - \$3.25 each



Scan to order online



7170 Bleeding Heart "King of Hearts" *

With a compact growth habit, 'King of Hearts' produces blooms in arching sprays of hot pink, heart-shaped flowers that will attract bees and butterflies. The blooms are complimented by the lacy fern-like, greyish-green foliage that forms a mound and lasts throughout the season. Great in containers or tucked in front of taller plants. Deer and rabbit resistant. Unlike common bleeding hearts, it will not go dormant in midsummer as long as the soil is kept moist. Ht 35 cm (14 in).

Each **A** \$14.95; 2 or more \$12.95 each.

Appetizing Apple Aroma

7985 Solar Mac

The McIntosh Apple Tree is famous for its fresh fruit, which boasts a light, tangy flavour. They are great apples for fresh eating or use them for baking and cooking in pies and sauces, and even apple cider. Not self-fertile, you will need to plant another variety to achieve fruiting. Our Honeycrisp apple tree makes an excellent tree for pollination. Solarmac produces apples that are medium in size, crisp, juicy, and having a white flesh. These apples will ripen mid September.

Each **A** \$58.95;
2 or more \$54.95 each.

Can be included in the
Apple Special on Page 93

Apples in Small Spaces!



7980 Northern Arrow Series "TreasuRed"

An exciting hardy columnar apple tree - an introduction from the University of Saskatchewan! Super compact with maximum yield! Instead of developing horizontal branches like standard apple trees do, these trees form fruit on short spurs that develop along the main trunk. Tree width is only 1 to 1.2 m (3 to 4 ft)! Mature height is 4 m (15 ft). The fruit is bright cherry red, large and smooth with a nice waxy bloom. Fruit ripens in mid-September with an excellent texture and flavour similar to a McIntosh apple, and stores well! They fit easily into the smallest gardens; you can plant several along a fence or deck.

Each **A** \$58.95;
2 or more \$54.95 each.

Can be included in the
Apple Special on Page 93

ALLIUM



7017 Lavender Bubbles

A late blooming perennial with dark purple lowers and attractive blue-green foliage. Easy to grow, deer and rabbit resistant.

Each **A** \$15.95; 2 or more \$14.95 each.